

Version: 01-2018



HOFFMANN
Machine
Company, Inc.

Operating and Maintenance Manual
MU3-P and MU3-PD
manual dovetail routing machine
Version: 7.205.00

Hoffmann Machine Company, Inc.
1386 Drexel Road Valdese, NC 28690 – USA
Ph: (828) 430 - 4510
www.Hoffmann-USA.com

1 Table of contents

2	WARNING AND SAFETY SYMBOLS USED IN THIS MANUAL	3
3	INTENDED USE AND OPERATION	5
	3.1 Transportation and Installation	5
	3.2 Technical Changes and Maintenance	6
	3.3 Operator and Maintenance Personnel.....	6
	3.4 Equipment Owner's Responsibilities	6
	3.5 Change of Ownership	6
4	MACHINE DESCRIPTION	7
	4.1 Terminology used in this manual.....	7
	4.2 Machine Description	7
5	TECHNICAL DATA AND SPECIFICATIONS	8
	5.1 Operator Environment.....	8
	6.2 Mechanical Dangers	9
	6.3 Defective equipment	9
	6.4 Electrical Dangers.....	9
	6.5 Cleaning agents and chemicals.....	10
	6.6 Remaining Risks	10
	7 Noise Emissions	10
8	WARRANTY AND LIABILITY	11
9	ELECTRICAL AND DUST COLLECTION CONNECTIONS	12
10	CHANGING ROUTER BITS	13
10	CHANGING ROUTER BITS - CONTINUED	14
11	ROUTER BIT ADJUSTMENTS	15
12	SELECTING KEY LENGTH AND SETTING ROUTING STROKE	16
13	CALIBRATING AND USING DIGITAL DISPLAYS (MU3-PD)	17
14	CALIBRATING TOP DISPLAY TO SET THE ROUTING STROKE	18
15	OVERVIEW - CENTER FENCE PLATE AND SQUARE STOP	22
16	EXAMPLES OF JOINING ANGLES OTHER THAN 45 DEGREES	23
17	STEP-BY-STEP INSTRUCTIONS FOR 45 DEGREE MITER JOINTS	24
18-A	ACCESSORIES FOR MU3-SERIES DOVETAIL ROUTING MACHINES	25
18-B	ACCESSORIES FOR MU3-SERIES DOVETAIL ROUTING MACHINES	26
19	ROUTER BITS FOR MU3-SERIES DOVETAIL ROUTING MACHINES	27
20	HOFFMANN DOVETAIL KEYS	28
21	HOFFMANN DOVETAIL KEYS	29
22	HOFFMANN DOVETAIL KEY SAMPLE CASES	30
23	TROUBLESHOOTING	31
24-A	MACHINE DRAWINGS AND PARTS LISTS	32
24-B	MACHINE DRAWINGS AND PARTS LISTS	33
24-C	MACHINE DRAWINGS AND PARTS LISTS	34
25	PNEUMATIC CIRCUIT DIAGRAM	35
26	TERMS AND CONDITIONS OF SALE AND WARRANTY	36

2 Warning and Safety Symbols used in this manual

Operator must read, understand and follow all safety rules, symbols and operating instructions at all times.

The following symbols are used in this operating manual:



Important Instructions

Instructions listed with this symbol must be strictly adhered to.



Safety Warning Symbol

This symbol warns of a possible danger.
Ignoring the safety instructions can lead to serious bodily harm and/or damage to the equipment and/or material being processed.



This symbol does not include a warning.
It is used to denote helpful hints and tips to improve the operation and performance of the equipment.

2.1 Warning and Safety Labels attached to machine

A number of important warning labels have been attached to this MU3-series dovetail routing machine for your information and protection.

For your own safety, please take a moment to locate and read all warning labels before operating this machine. If a label has been removed, defaced or is illegible, please contact Hoffmann Machine Company, Inc. to request a free replacement.

Please note that not every label shown may be attached to the machine and labels are subject to change.

NEVER REMOVE ANY SAFETY OR WARNING LABEL!

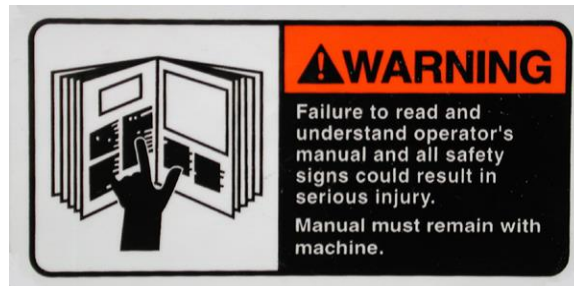

3 Intended Use and Operation

The HOFFMANN MU3-series dovetail routing machines are designed solely for manually routing dovetail keyways for Hoffmann Dovetail Keys into solid hard and soft wood, wood-related materials such as MDF, plywood, particleboard and certain plastic materials.

Dovetail Keyways in sizes W-0, W-1, W-2 and W-3 can be routed with the standard router motor, a larger 1,000 watt router motor is recommended for use with W-4 router bits.

All work pieces must fall within the following dimensional parameters:

Dimension	MIN (mm)	MAX (mm)
Width	10	Unlimited (with optional accessories)
Thickness	10	125
Length	100	unlimited



Using HOFFMANN MU3-series dovetail routing machines for any other operation or material can result in unforeseen dangers and is expressly forbidden!

The manufacturer is not liable for any damages resulting from unapproved use or operation of the equipment. The operator is solely responsible for any such risks and dangers.

The equipment may not be copied or dismantled for the purpose of duplication of all or part of the design or operation.

Technical changes to this equipment require the prior written consent of the manufacturer.

Any changes, additions, removal of components, etc. not expressly permitted in writing by the manufacturer will immediately void the warranty. Any risks, dangers or damages resulting from unauthorized modifications are solely the responsibility of the user/operator.

Adjustments on moveable components of HOFFMANN MU3-series dovetail routing machines during the operating process are only permitted if such adjustments are required for the proper operation of the equipment and if such adjustment procedures are outlined in this manual. All pertinent safety rules and regulations are to be strictly adhered to.

3.1 Transportation and Installation

Hoffmann MU3-series dovetail routing machines are shipped in sturdy cardboard boxes which are strapped to shipping pallets for transport.

Carefully check outer carton for any shipping damage before accepting delivery and compare packing list with included items and accessories. Inform shipping company and Hoffmann Machine Company, Inc. immediately of any shipping damage, take photographs and note damage on Bill of Lading.

Remove all strapping and packaging and carefully lift machine out of its carton. To avoid possibility of injury, we strongly recommend two people work together to lift machine and place it on a suitable table or workbench.

Clean off oil film from machine table, fences (also underside of fences and square stop) with paper towels and non-corrosive cleaner (e.g. SIMPLE GREEN, Citrus Cleaner, etc.) before connecting electrical power and compressed air supply.

Connect machine power cord to 120 volt outlet or suitable extension cord. Always use shortest extension cord possible. Use a suitable compressed air line and connect machine to compressed air supply. Customer is to supply male fitting with 1/4" NPT thread for pressure regulator.

3.2 Technical Changes and Maintenance

Technical changes or alterations of any kind are only permitted if the prior written authorization from Hoffmann Machine Company, Inc. has been secured.

Never remove safety guards and shields, remove or by-pass safety devices, switches, sensors, use or install tooling other than originally supplied.

The manufacturer is not liable for any injuries or damages caused by unauthorized changes, removal or add-ons to this equipment.

Only trained, qualified personnel may perform installation, set-up and maintenance procedures as well as replacement of parts or components of any kind.

3.3 Operator and Maintenance Personnel

Machine operator and maintenance personnel may only perform activities described in this manual.

Persons working on or with this machine must be at least 18 years old, they must be thoroughly familiar with this operating manual and they must adhere to all local safety rules and regulations. All OSHA specified rules must be followed if applicable.

Persons working on or with this machine must wear suitable clothing designed to avoid entrapment in rotating machine components.

No loose fitting clothes e.g. ties or shawls, or bracelets, wristwatches, necklaces, etc. may be worn when operating this machine.

Persons with long hair must tie their hair securely and wear an appropriate hair covering to avoid entanglement.

3.4 Equipment Owner's Responsibilities

The owner of the equipment must make this operator manual available to all machine operators and maintenance personnel. The equipment owner must assure that all operators and maintenance personnel are qualified to work on this equipment and that they have read and fully understand this operator manual, especially all sections pertaining to possible dangers and safety rules.

The owner must assure that all areas of responsibility, including set-up, operation, maintenance, etc. – are clearly defined and explained.

All responsibilities must be assigned to and understood by all involved persons to avoid the risk of injury and /or damage to material.

The owner is responsible for the adherence to all applicable safety rules and regulations.

The owner is responsible for the proper and safe condition of the machine; he is further responsible for the proper installation and set-up and he must provide a safe and secure work environment.

The owner must be familiar with and is responsible for the adherence to any and all local and national safety rules and regulations pertaining to this equipment.

The manufacturer is not liable for any injuries or damages as a result of non-compliance with, or adherence to, applicable safety rules and regulations.

If the operator and/or maintenance personnel do not understand English, the owner must provide a properly translated operator manual to assure the safety of all personnel.

3.5 Change of Ownership

In case of sale of this equipment all components, tools, manuals, safety instructions, accessories as well as any electronic or software updates you have originally received with the machine must be included.

This includes any and all operator manuals, maintenance instructions, equipment or components replacement parts, etc.

4 Machine Description

4.1 Terminology used in this manual

- MU3-series = **HOFFMANN MU3-P or MU3-PD Dovetail Routing Machine**
- Bit = Hoffmann dovetail router bits in sizes W-0, W-1 / W-2 / W3
- Workpiece = User supplied moulding profiles made of wood or wood related materials
- Dovetail Key = HOFFMANN Dovetail Keys

4.2 Machine Description

HOFFMANN MU3-series dovetail routing machine consists of:

- HOFFMANN MU3-series dovetail routing machine
- 45 degree center fence plate with locking lever
- 90 degree square stop with locking lever
- One Hoffmann router bit installed
- Toolkit
- Operating manual



Hoffmann MU3-P pneumatic dovetail routing machine
(shown with optional accessories)



Hoffmann MU3-PD pneumatic dovetail routing machine
(shown with optional accessories)

5 Technical Data and Specifications

<u>Electrical Power Supply</u>	
Supply voltage	120 volt, single phase
Frequency	50-60 Hz
Input Amperage	8 A
Motor Speed	34,000 rpm
Collet Size	1/4" (6.35mm)
Router motors	Hoffmann router motor Type UAD-33 885 watt – 120 volt
Router bits	Hoffmann Dovetail Router Bits, size W0 / W1 / W2 / W3
<u>Compressed Air Supply:</u>	
Compressed Air Requirements	90 psi (6bar) clean and dry air Approx. volume 1liter/cycle = 0.04 cubic feet / cycle
<u>Other Specifications</u>	
Work piece material	Wood and wood related materials and certain plastics
Machine performance	Up to 40 cycles/hour (depending on operator, material flow, material quality, etc.)
Weight	approx. 71 lbs.
Dim. Length x depth x height	approx. 29 1/4" x 25 1/2" x 32 7/8"
<u>Noise emissions:</u>	
Sound Pressure Level (SPL):	75.3 dB (A)
<u>Machine Environment</u>	
Temperature range for operation	59.... + 104 F
Temperature for storage / transport	32.... + 140 F
Temperature change during operation	max. 20 F
Temperature change during storage / transport	max. 40 F
Relative humidity according to DIN 40040	15... 80 % without condensation at 95 F
Air pressure during operation	860-1060 hPA (bar)
Air pressure during storage / transport	860-1060 hPA (bar)

5.1 Operator Environment

The work areas for the operator have been designed with ergonomic principles in mind.

The machine owner is responsible for ease of access, adequate lighting, fresh air supply, etc.

Rules for safe work areas:

- ⇒ The work area must be free from clutter and must be kept neat and unobstructed. Local and national safety rules, including but not limited to all applicable OSHA Rules must be adhered to.
- ⇒ Access space of no less than 24" shall be available on all sides of the machine for set-up and maintenance procedures.
- ⇒ All electrical supply lines must be securely fastened in accordance with all local and national safety codes. Secure all wires, hoses and lines and do not allow lines to lie on the floor as they may present a trip hazard to the operator. Supply lines, wires and hoses must be inspected periodically and replaced if any damage is observed.
- ⇒ The environmental conditions must meet the guide lines given under section 5 "Technical Date and Specifications"

6 Potential Sources of Danger

6.1 Unapproved Use

Unapproved procedures are:



Processing work pieces made of material other than solid wood or wood related material such as MDF, particle board, plywood, etc.

- Operating of the machine by more than one operator at the same time.

Unapproved use and/or misuse of the machine can result in the following:

- ⇒ Minor to severe injuries to the machine operator and/or bystanders.
- ⇒ Damage to the machine and/or work pieces.

6.2 Mechanical Dangers

During operation of this machine sharp router bits rotate at high speeds. These components can cause severe injury if hair or clothing or extremities become entangled.

Never reach into the machine during operation!!



Only make adjustments during operation if these adjustments are absolutely necessary and if the procedure is fully outlined and approved in this operator manual.

6.3 Defective equipment

If the machine does not function properly and if the fault cannot be rectified immediately, the equipment must be shut down by the person responsible for the operation.

Signs of defective are:

- ⇒ The machine shows signs of mechanical damage.
- ⇒ Electrical wires or cables are damaged.
- ⇒ The machine was stored or has not been in use for an extended period of time in an unsuitable environment, for example in high relative humidity or too high or too low temperature.

6.4 Electrical Dangers

- ⇒ Dangerous electrical current is present in different locations inside of the machine's limit switch when the power cord is plugged in, even if the machine is not being operated and the motor is switched off. Do not remove any switch cover or motor end cap.
- ⇒ Never use damaged or worn cables, wires, supply lines or electrical components or parts on this machine.

6.5 Cleaning agents and chemicals



Review and observe all safety rules provided by the chemicals manufacturer while working with cleaning agents and other chemicals. Read and understand the Material Safety Data Sheets (MSDS) provided by the manufacturer and follow all safety precautions described therein.

- ⇒ Always wear proper protective gear, including safety glasses and gloves, when using cleaning agents, degreaser, etc.
- ⇒ Do not eat, drink or smoke when using chemicals.
- ⇒ Dispose of used cleaning agents and other chemicals in accordance with all State and local laws.

6.6 Remaining Risks



If the operator does not pay attention, it is possible to squeeze ones' fingers when loading and manually clamping a work piece. Never place your fingers under the clamp pads of the material clamp pad or in the path of the router bit.

7 Noise Emissions



The machine generates a work place Sound Pressure Level (SPL) of approx. 75.3 dB(A) when processing a work piece.

Local conditions could increase the SPL, which could cause hearing damage or loss.

The machine owner must provide suitable protective gear to protect employees from hearing damage, as required by local and state laws and OSHA regulations.



Notes:

All listed values are measured noise emission levels – they are not necessarily safe working environment levels.

Local conditions, the proximity of walls and ceilings, the type of wall, ceiling and floor material as well other equipment in close proximity could affect the total noise emissions at the work place.

The SPL values are provided as information only and it is recommended that the machine owner measure the actual local noise levels after installation.

Machine is owner is responsible for providing suitable protective gear depending on total noise emissions and local and state laws and regulations.

All OSHA regulations pertaining to noise protection are to be adhered to.

8 Warranty and Liability

The „Hoffmann Machine Company, Inc. Terms and Conditions of Sale“ are the basis for all dealings between the manufacturer and the customer. These Terms have been made available to the customer during the proposal and order processing stage.

In addition to the complete Terms and Conditions of Sale, any of the following conditions immediately voids the warranty and releases the manufacturer from any and all liability.

- ⇒ Unapproved use of the machine.
- ⇒ Improper installation, start-up, maintenance or operation of the machine.
- ⇒ Operation of machine with defective, missing or by-passed safety devices of any kind.
- ⇒ Non adherence to any rule or regulation in this operator manual.
- ⇒ Unauthorized changes to the machine or any of its components
- ⇒ Insufficient supervision and maintenance of parts subject to normal wear and tear.
- ⇒ Damage due to unforeseen circumstances, acts of God, etc.
- ⇒ Improper or unauthorized repairs or use of tooling (router bits not supplied by Hoffmann, Inc.

9 Electrical and Dust Collection Connections

Hoffmann MU3-series dovetail routing machine are equipped with power cords for 120 volt US household current.

Connect the power cord to a suitable outlet or, if using an extension cord, use the shortest extension cord possible. Check to make sure extension is undamaged in safe working order.

Dust Collection

The machines are equipped with a 50mm (2") diameter dust collection port, located underneath the router bit. The port is accessed by carefully tilting the machine forward.

Connect a properly sized suction hose from shop vacuum or connect the dust collection hose to central dust collection system.

Proper dust collection should always be used for best results and to keep the machine and work area as clean as possible.

A minimum suction value of 150 cubic feet per minute is required.

When using a shop vacuum, we recommend using a model with build-in "tool trigger outlet" to cycle the vacuum on and off with the routing machine. This reduces strain on the vacuum, it greatly reduces noise levels and it extends the life of your vacuum.

If your vacuum is not equipped with a tool-trigger outlet, aftermarket accessories are available online from retailers like Amazon.com, etc.

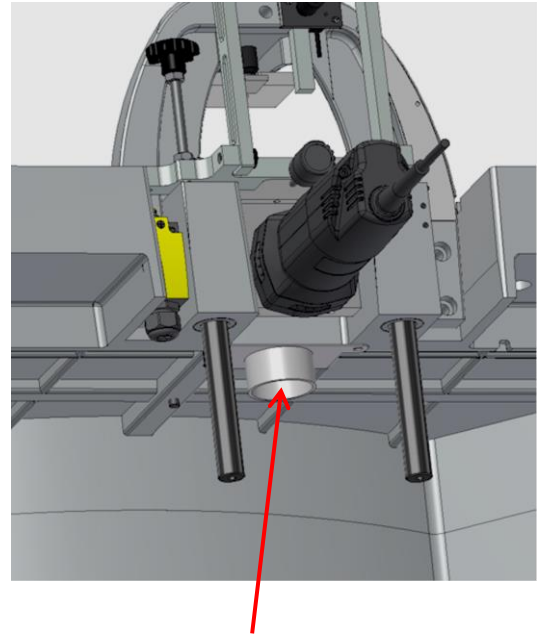

This is an example of an add-on tool trigger outlet available online. It is shown as an example only, other models and sizes may be available.



10 Changing Router Bits



ALWAYS DISCONNECT THE ELECTRICAL POWER AND COMPRESSED AIR SUPPLY BEFORE ATTEMPTING ANY SERVICE, MAINTENANCE OR REPAIR WORK!

Follow proper “Lock-Out / Tag-Out” procedures as specified by the Occupational Safety and Health Administration “OSHA” if applicable.

1. Verify that electrical power and compressed air line have been disconnected – keep power cord and air line in your line of sight.
2. Remove the old chip breaker from the table recess and discard. 
3. Loosen the lock-nut (1) and raise the motor carriage manually by turning the black star knob (2) on the right side of the motor carriage. Raise the carriage until the router bit is approx. 1/4”-3/8” above the machine table.
4. Loosen the Allen head screw (3) on the underside of the motor bracket to release the motor. Carefully slide the motor out toward the back.
5. Use the included open-end wrenches (SW18mm and SW22mm) to open the 1/4” collet nut and remove the old router bit.
6. Install new bit and tighten collet securely.

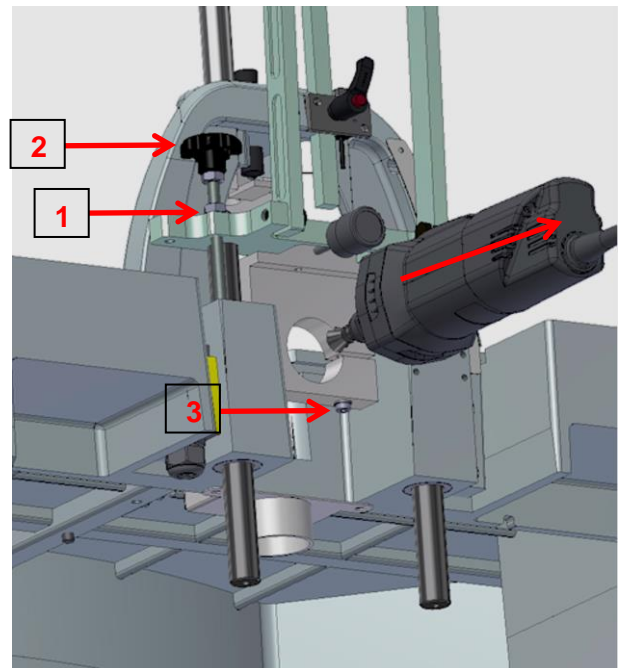

7. Distance (German: **Einstellmaß**) between tip of router bit and top of collet should be (approximately):
 - For W-0 router bit: 14.3 mm = 0.563”
 - For W-1 router bit: 15.5 mm = 0.610”
 - For W-2 router bit: 17.0 mm = 0.669”
 - For W-3 router bit: 19.0 mm = 0.749”
 - For W-4 router bit: 24.2 mm = 0.953”

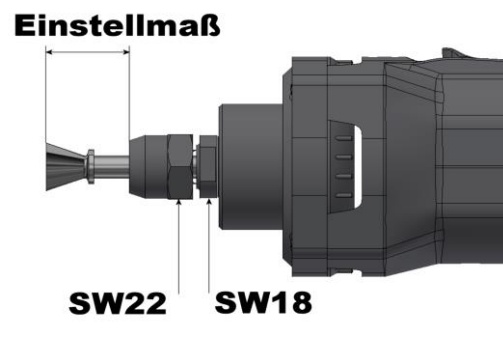

When installing a new bit try to get close to the listed dimensions but don't spend too much time trying to get a “perfect” setting. The final adjustment will be made by moving the whole motor in and out – see next page!

10 Changing Router Bits - continued

8. **Slide the motor all the way into the motor bracket** and tighten the Allen head screw (3 on previous page) by hand.
9. Loosen the Lock-Screw or Locking Lever (4) on top of the motor bracket and adjust the motor in or out by moving the motor fine adjustment knob (5)
10. Use the square stop (6) to set the proper distance. The stop has three steps in one side (W1, W2, W3) and one large step machined in the opposite for W4 router bits.
11. Slide the square stop out of the fence rail and remove the locking lever, washer and square nut. Place the stop upside down on the table and push it tightly against the back fence. Turn the motor fine adjustment knob (5) until the tip of the router bit (7) touches the corresponding step. Use the smallest step for W-1, the middle step for W-2 and the deepest step for W-3.
12. Tighten the Lock-Screw or Locking Lever (4) on top of the motor bracket and lower the carriage to its home position.
13. Connect air and electrical power and make a test cut and verify proper settings by inserting a Hoffmann key – adjust setting if necessary
14. Disconnect air and switch OFF router motor, then raise the carriage and install a new chip breaker insert. Place a piece of scrap wood over the insert, switch ON motor and slowly lower the running router bit down through the wood. The scrap wood eliminates tear out on the surface of the chip breaker.
15. Hold the scrap wood securely in place and be aware of the turning bit at all times. Lower the router carriage by turning the black star knob slowly. When the motor has shut off, secure the threaded stem with the locknut.

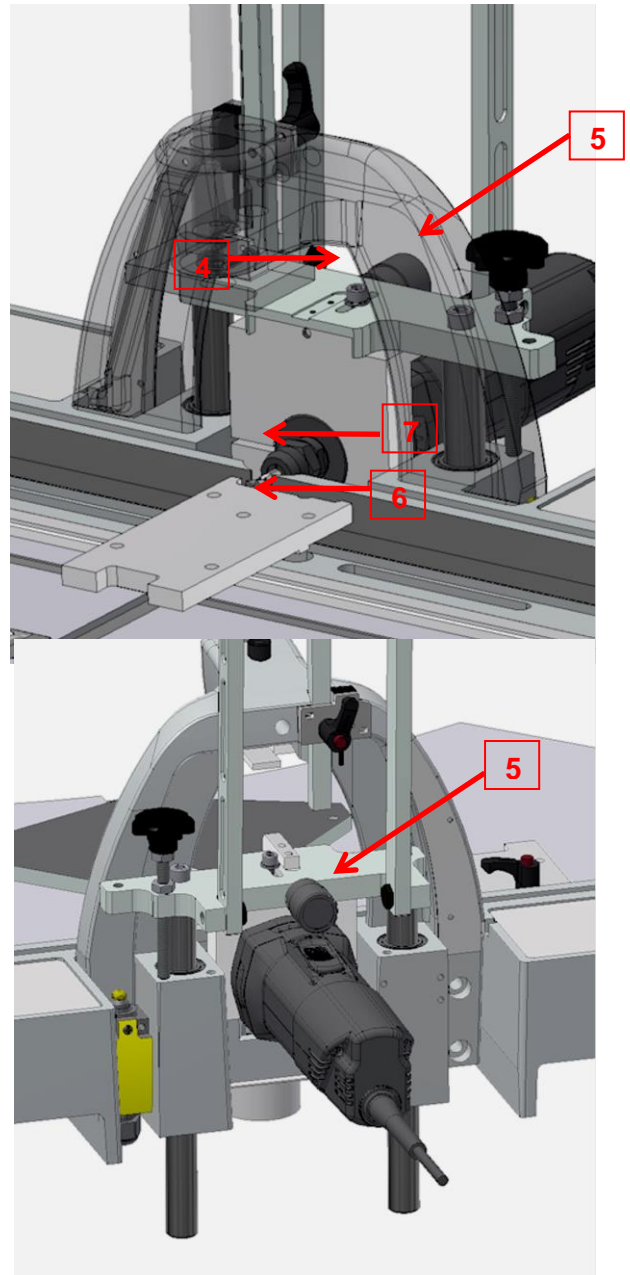

Important Tip!

Due to its weight, the rear of the motor will tilt downward when the Lock-Screw or Locking-Lever (4) is loosened. Before using the motor fine adjustment knob (5), lightly re-tighten the Lock-Screw or Locking-Lever just enough to bring the rear of the motor back up. If the motor is left too loose while turning the adjustment knob, subsequent tightening of the Lock-Screw or Locking-Lever will bring the motor back to its proper horizontal position and cause the router bit projection to be off.



Always wear safety glasses when operating this machine!

11 Router Bit Adjustments

Hoffmann Dovetail Keys are designed to create permanent and reliable joints in a wide range of wood products.

For optimum strength and reliability, it is important to adjust the router bits properly.

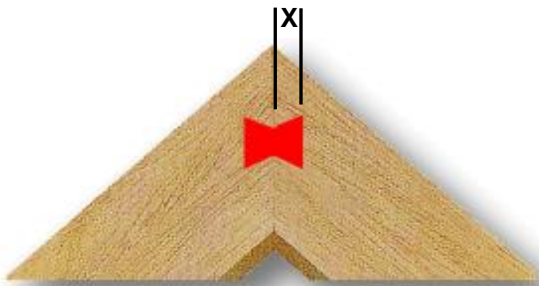

The medium or factory settings for the router bit projection (measurement “X”) are:

Size W0	2.3 mm	0.0906”
Size W1	3.5 mm	0.1378”
Size W2	5.1 mm	0.2008”
Size W3	6.9 mm	0.2717”
Size W4	12.1 mm	0.4764”

These are the minimum setting at which the Keys will still create a tight joint.

If the material allows, a deeper setting will increase the “draw” or “pull” of the Key.

Incorrect:

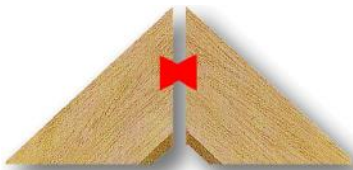

If the router bit projection is set too shallow, the Key is not able to pull the miter faces together. An open joint is the result.

Incorrect:



If the router bit projection is set too far, the Key and/or the material can split resulting in damage to the material.

Final router bit adjustments are always made by moving the router motor in or out as needed.

A small movement will make a noticeable difference!

We recommend the use of our Digital Multi Gauge (W20001300) for precise adjustments.

Tip:

Do not try to fine tune the router bit projection by moving the bit in or out of the collet – it is much easier, more precise and faster to move the whole motor instead of only the bit.

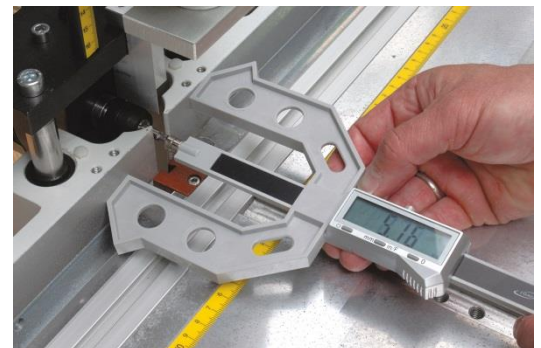

12 Selecting Key Length and Setting Routing Stroke

The machine is equipped with a routing height tape scale (1) which is attached to the routing height adjustment bar (2). The scale indicates the height the router bit will travel into the material.

To adjust the height, simply loosen the locking lever (3), move the bar to the desired height and tighten the locking lever,



Always use the longest Key possible to achieve a tight joint on the face side of the workpiece!

All Dovetail Keys listed on our website www.hoffmann-usa.com have the recommended material thickness listed.

For example, W2 – 5/8" Keys are listed as:

W2 – 5/8" Keys for 3/4" and thicker stock

Do not use Keys which are too short as the resulting joints will not be as strong or tight as they could be.

If correct length Keys are not available, stacking two Keys is advised.

When using Solid Wood Dovetail Keys it is important to remember that wood Keys are only intended to be a decorative item. They should not be used alone as a fastener. Due to the grain direction and possible dimensional variations with changes in humidity the inherent strength of wood Keys is less than that of our plastic Keys.

We strongly recommend to use a plastic Key for strength and "cap" it with a wood Keys for looks.

Wood Keys are available in 12" lengths and are easily cut to any length.



A fine toothed handsaw (Japanese Style) is a safe way to cut wood Keys to length.

For larger quantities we found using a bandsaw with a fine toothed blade is safer than any type of miter or chop saw.

Always read and follow all safety instructions that came with your power tools!

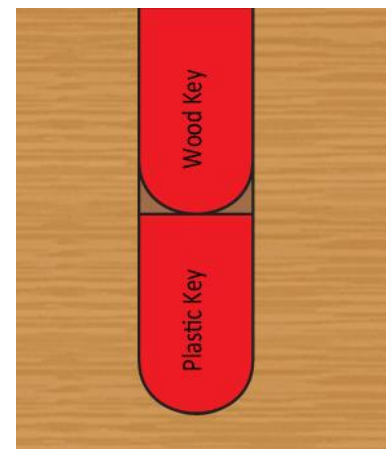
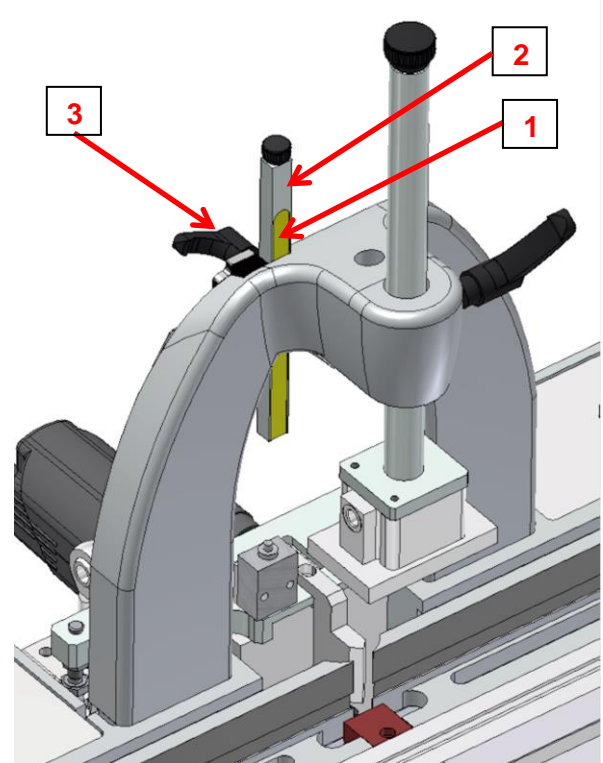

W-2



W-3



W-4

13 Calibrating and Using Digital Displays (MU3-PD)

Hoffmann MU3-PD dovetail routing machines are equipped with a dual LCD (liquid crystal display).

- 1 Display for routing height
- 2 Display for keyway location
- 3 Compressed air connection
- 4 Height adjustment bar with magnetic tape
- 5 Locking lever for height adjustment bar
- 6 Sensor for routing height bar
- 7 Sensor for keyway location
- 8 Locking Lever for fence plate
- 9 Fence plate with magnetic tape
- 10 Pneumatic valve with pin plunger
- 11 Workpiece Hold-Down Clamp

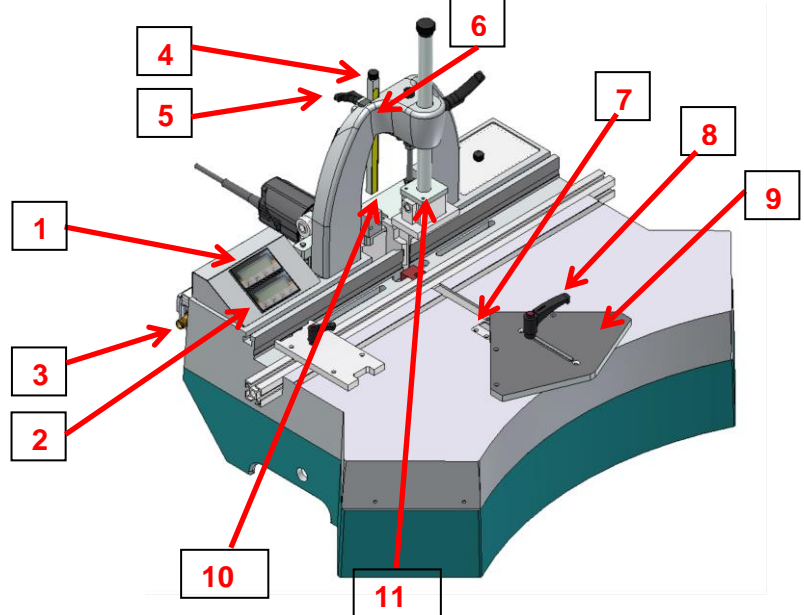

The **Top Display** is used to set the routing stroke or dovetail keyway length.

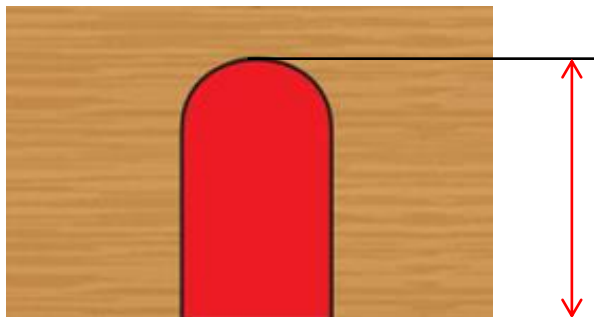

The **Bottom Display** is used to indicate the distance from the tip of the miter to the center of the keyway.

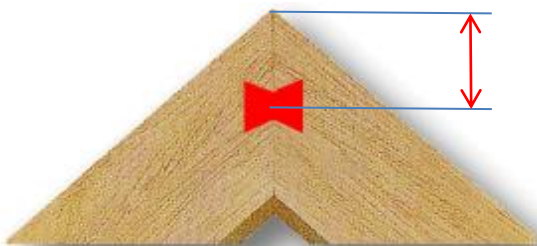

14 Calibrating Top Display to set the routing stroke

1. To calibrate the routing stroke display, the exact “switching point” of the pneumatic valve (10) must be determined.
2. Set routing height adjustment bar (4) to “0” and place a scrap piece of wood in the machine.
3. Lower the hold down clamp (11) to approx. 1/16” – 1/8” above the material and make a test cut
4. Multiple test cuts with the routing height adjustment bar moved slightly up or down may be necessary to find the exact spot where the router bit just barely touches or “scratches” the test piece.
5. Press buttons “F” and “SET” on upper digital display to reset display to “0” (zero)
6. **Display is now calibrated to show “0” when tip of router bit is flush or level with table surface.**

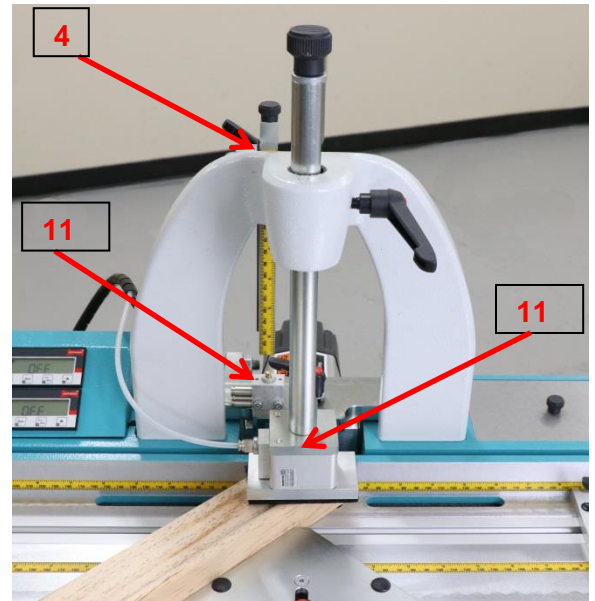





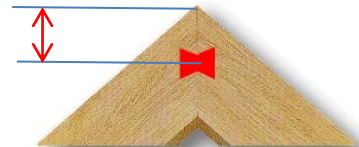



14.1 Calibrating Bottom Display to set keyway position.

The minimum distance from the miter tip to the center of the dovetail keyway on MU-3 series machines is 3.2mm or 0.125”.
(In other words, when the Center Fence Plate is moved all the way forward, the keyway will be routed 3.2mm or 0.125” from the miter tip.)



Calibrating the keyway location display is slightly different from the routing height display in that the “starting point” or “reference position” is not “0” (zero) but it must read 3.2mm or 0.125”.

1. Remove locking lever for fence plate (8) and slide fence plate (9) all the way forward (toward motor).

2. Press  for 3 seconds to enter Parameter Mode
3. Press  repeatedly until Parameter 9 (P9) is reached
4. Press  again to display numeric values
5. Press  to select digit you wish to change
6. Press  to increase value of digit in one step increments
7. Press  again for 3 seconds to return to normal operating mode.
8. Press  and  simultaneously to calibrate display to newly stored reference number 3.2mm 0.125”

1. Loosen or remove locking lever for fence plate (8) and slide fence plate (9) all the way forward (toward motor).



2. Press  for 3 seconds to enter Parameter Mode



3. Press  repeatedly until Parameter 9 (P9) is reached



4. Press  again to display numeric values



5. Press  to select digit you wish to change





6. Press  to increase value of digit in one step increments



7. Press  again for 3 seconds to return to normal operating mode.



8. Press  and  simultaneously to calibrate display to newly stored reference number 3.2mm 0.125"



14.2 Checking display after calibration.

1. Use a ruler or digital caliper and mark a random distance from miter tip to keyway center with a pencil (we used 25.00mm as example)



2. Place workpiece on machine and adjust center fence plate until pencil mark is aligned with Center Line Locator

Display should read the same or very similar to measurement on caliper (slight variation may be due to reading errors, width of pencil line, etc.)

If distance shown on display varies by more than 0.5mm, adjust reference value in Parameter 9 up or down as needed.



14.3 “Waking Up” display from battery saving mode

Both digital displays will enter “sleep mode” after a few minutes to extend battery life.

Displays are switched back on to active mode every time any button is pushed and anytime either the height adjustment bar or the center fence plate is moved.

The length of time until display enters sleep mode is factory set and cannot be changed. However, sleep mode can be turned off in Parameter 4. Please note that without sleep mode the battery life is greatly reduced.

14.4 Parameter Listing for ELGO IZ14E Digital Liquid Crystal Display

Parameter	Specification	Default Setting
P01: A	Counting Direction A = 0 positive counting direction A = 1 negative counting direction	0
P02: A	Display Mode A = 0 display “mm” A = 1 display “inch” A = 2 display “m” A = 3 display “°” A = 4 no symbol displayed	0
P02: A	Decimal Point -- can be set from 0...4	2
P04: A	Sleep Mode A = 00 display always on (not recommended) A = 01 sleep mode on	01
P05: ABC	Push Button Lock Options A “SET” 0 – unlocked 1 – locked B “Incr/ABS” 0 – unlocked 1 – locked C “*” 0 – unlocked 1 - locked	000
P07: A	Resolution A = 0 resolution 0.01mm A = 1 resolution 0.1mm	0
P08:	Multiplication Factor (0.0001...9.9999)	1.0000
P09:	Reference Value (-9.9999...+9.9999)	0.0
P10:	Offset # 1	0
P11:	Offset #2	0
P12:	Offset #3	0
P13: A	Offset Configurations	3
P99:	Software Version	x.xx

15 Overview - Center Fence Plate and Square Stop

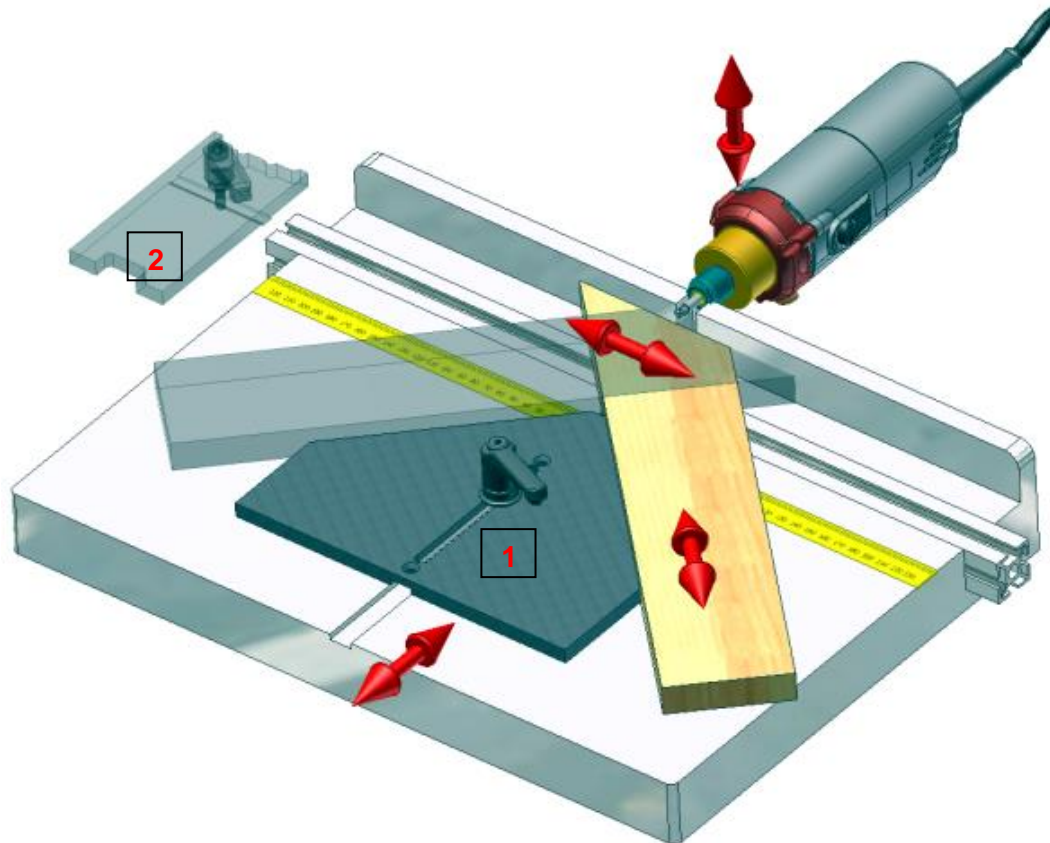

Hoffmann Dovetail Joining Machines are equipped with an innovative fence system for joining miter joints at any angle as well as square or butt joints, end-to-end joints, etc.

MU-3 series machines are equipped with a Center Fence Plate (1) and a Square Stop (2).

Adjusting the center fence plate in or out determines the locations along the miter face at which the dovetail keyways are being routed.

Once set and locked in place, left and right hand parts are processed for perfectly aligned miter joints.

The standard 45 degree fence plate allows for processing of up to 120mm – 4 3/4" wide moulding.

Wider material can be processed with optional Inside Corner Fences.

Custom parts with miter cuts other than 45 degrees, as well as square joints can be processed with the included square stop.

The recessed tape scales in both the table and rear fence are used to accurately set the square stop.

16 Examples of joining angles other than 45 degrees

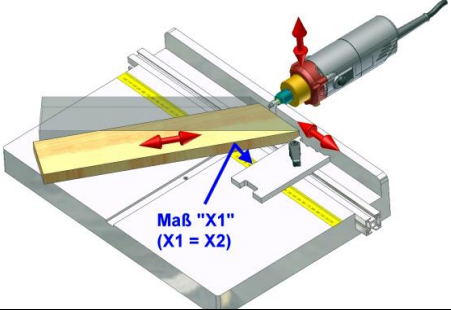
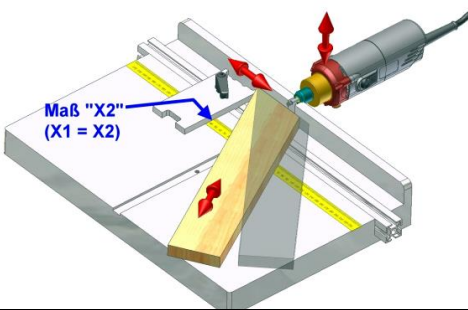
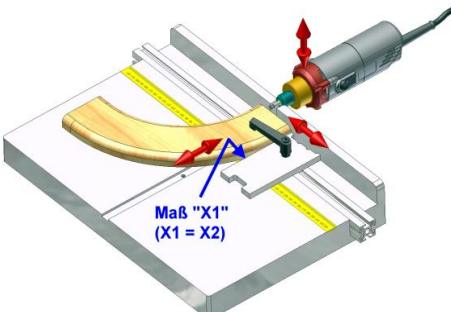
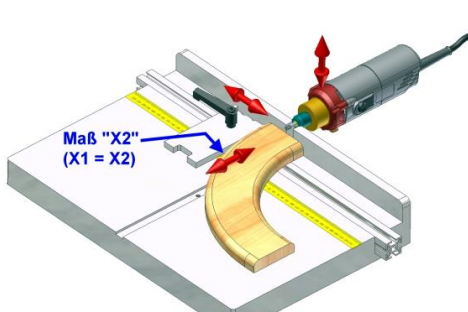
Material	Processing Part 1	Processing Part 2
Joining parts at any angle		
Joining radiused parts		

17 Step-by-Step Instructions for 45 degree miter joints

1. Select proper Dovetail Keys for the material being joined by always using the longest Keys possible.

For example, for 1/2" thick material use 3/8" long Keys, for 3/4" thick material use 5/8" long Keys, for 1" thick material use 7/8" long Keys, etc.

If correct Key size is not available, it is better to stack multiple Keys than to use a single, short Key.



2. Set the routing height by adjusting the height adjustment bar to the desired setting.

TIP: Hold a Dovetail Key against the bar for quick setting.

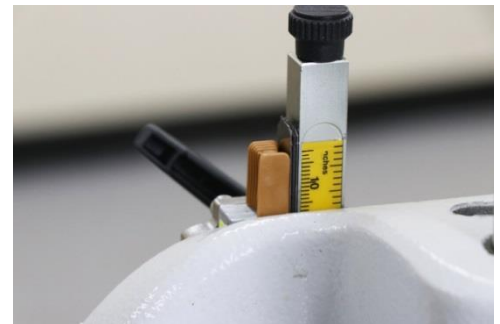

3. Select the key locations along the mitered end, depending on the material being joining.

For profiled moulding, try to place Keys in thicker portions for best results. Generally, moulding over 1 1/4" (32mm) wide should be joined with two Dovetail Keys for added strength.



4. Place workpiece on table and adjust Center Fence Plate by moving it in or out until desired keyway location is set. Use the Center Line Locator and/or digital display is so equipped.

5. Lock the Center Fence Plate in place with the locking lever and lower the material hold-down clamp to within 1/16" – 1/8" above the material.



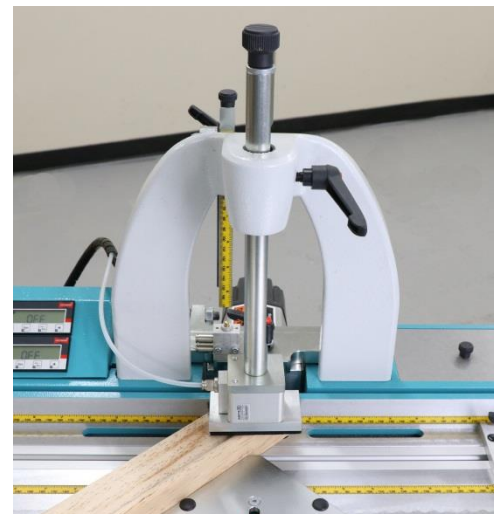

6. Place workpiece tightly against fence plate while pushing mitered end against back fence.

6. Step on the pneumatic foot switch to activate the routing sequence. The hold-down clamp will secure the material on the table, the router motor will switch on and raise up until the pre-set height is reached, then return down below the table.





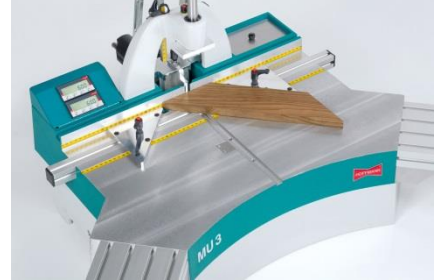

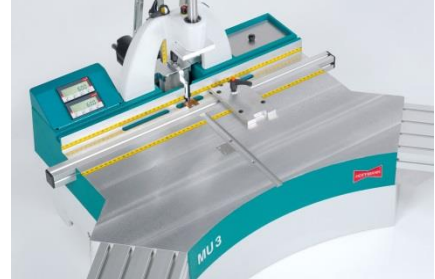
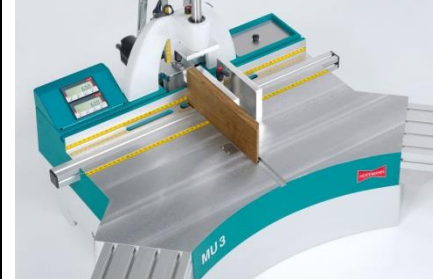
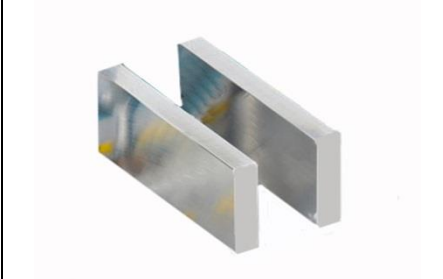
7. The motor will switch off and the hold down clamp will release the material.

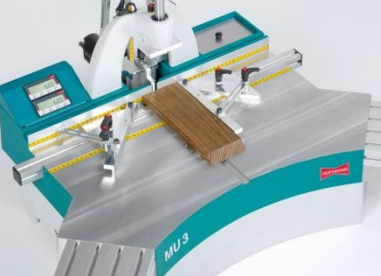

18-a Accessories for MU3-series dovetail routing machines

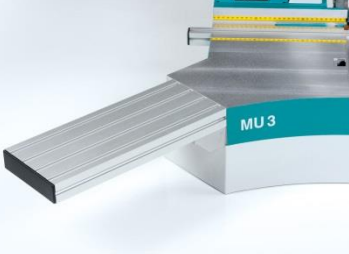
<p>W3060001 Fence Plate for 45 degree miter joints</p>	<p>W3060002 Fence Plate, 45 deg. with height extensions</p>	<p>W3017000 Fence Plate Height Extension Kit</p>
		
<p>This fence plate is supplied with the machine as standard equipment</p>	<p>Left and right side height extensions help hold tall material perfectly aligned.</p>	<p>Aluminum height extension set for installation on Fence Plate W3060001</p>
<p>W3011004 Inside Corner Fences left and right</p>	<p>W3011005 Inside Corner Fences w. height extensions</p>	<p>W3019000 Inside Corner Fence Height Extension Kit</p>
		
<p>For referencing off inside moulding edge and for routing two keyways per miter.</p>	<p>For referencing off inside moulding edge when joining tall material</p>	<p>Height extensions for installation on Inside Corner Fences W3011004</p>
<p>W3020001 Square Stop for MU-3</p>	<p>W3020002 Square Stop with Height Extensions</p>	<p>W3018000 Square Stop Height Extension Kit</p>
		
<p>This Square Stop is supplied with the machine as standard equipment</p>	<p>Gives added support for end-to-end and butt joints on tall material</p>	<p>Aluminum height extensions for installation on Square Stop W3020001</p>

18-b Accessories for MU3-series dovetail routing machines

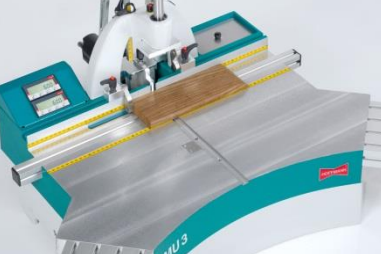
<p>W3011000 SYNCHRO Adjustable Center Fence</p> 	<p>W3012001 Adjustable Inside Corner Fences</p> 	<p>W3021000 Compound Miter Fixture Set</p> 
<p>Fully adjustable from 0-90° for custom joinery of any angle miter joint.</p>	<p>Fully adjustable from 45-90° for custom joinery applications.</p>	<p>Adjustable Fixture Kit for joining crown moulding with compound miters.</p>
<p>W3015000 Table Extensions</p> 	<p>W3029000 Fence Rail Extensions</p> 	<p>W3028000 Routing Stroke Limiter</p> 
<p>Anodized aluminum table extension kit, left and right side, with mounting brackets</p>	<p>Anodized aluminum fence rail extension, 1000mm (39.4") long, with connector kit</p>	<p>Routing stroke limiter for MU3 and MU3-D Limits routing depth to avoid cut-throughs</p>
<p>W3024000 Table Flip Stop</p> 	<p>W3022000 Flip-Stop for Fence Rail Extension</p> 	<p>W3023000 Flip Stop for Rear Fence</p> 
<p>Spring-loaded steel flip-stop with set-screw for use in table fence rail & extension rails</p>	<p>Sturdy flip-stop with locking lever, reversible for left and right hand use</p>	<p>Sturdy flip-stop with locking lever, reversible for left and right hand use</p>

19 Router Bits for MU3-series dovetail routing machines

Standard HOFFMANN Dovetail Router Bits		
W-0 solid carbide dovetail bit with 1/4" shank	W2006350	
W-1 solid carbide dovetail bit with 1/4" shank	W2016350	
W-2 solid carbide dovetail bit with 1/4" shank	W2026350	Factory installed bit
W-3 solid carbide dovetail bit with 1/4" shank	W2036350	
W-4 dovetail bit with 8mm shank	W2048000	Requires 8mm collet and larger 1,000 watt motor
Oversized HOFFMANN Dovetail Router Bits		
W-1 solid carbide oversized dovetail bit with 1/4" shank	W2016352	Slightly oversized bit to reduce pressure in thinner material
W-2 solid carbide oversized dovetail bit with 1/4" shank	W2026352	Slightly oversized bit to reduce pressure in thinner material
W-3 solid carbide oversized dovetail bit with 1/4" shank	W2036352	Slightly oversized bit to reduce pressure in thinner material
Ti-AL-N coated HOFFMANN Dovetail Router Bits		
W-1 Ti-AL-N coated carbide dovetail bit with 1/4" shank	W2016351	Ti-AL-N coated for longer life
W-2 Ti-AL-N coated carbide dovetail bit with 1/4" shank	W2026351	Ti-AL-N coated for longer life
W-3 Ti-AL-N coated carbide dovetail bit with 1/4" shank	W2036351	Ti-AL-N coated for longer life
W-4 Ti-AL-N coated carbide dovetail bit w. 8mm shank	W2048001	Requires 8mm collet and larger 1,000 watt motor

Every new bit is shipped with a new, un-cut phenolic chip breaker included. Chip breakers should be replaced every time a new bit is installed and whenever they are worn or damaged. Additional chip breakers can be ordered under part number W20000



HOFFMANN Digital Multi Gauge

Instead of using the steps in the square-stop (see page 16), the HOFFMANN Digital Multi Gauge can be used to set precise router bit projections on the machines. The digital read-out allows precise setting of router bits which is especially helpful in cases where a little less or more draw (or clamping force) is required. For example, when joining small floater frames the draw can be reduced and on large, heavy moulding the draw can be increased to suit individual needs. The gauge features a large, easy-to-read display which can be switched from millimeter to inches. Aside from setting router bits on Hoffmann machines, the gauge is used in woodworking shops to set sawblades on table saws, bits in router tables, to measure dado and groove depths, etc.

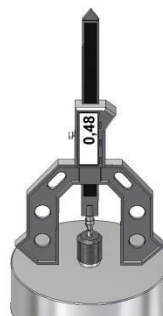
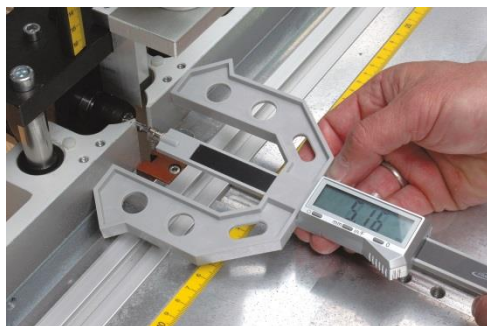

• Total measuring range:	• 5" (3" up and 2" down)
• Resolution:	• 0.0005", 1/64"
• Accuracy:	• 0.001" per 1"
• Battery:	• 3 volt, type CR2032 (included)
• Frame:	• heavy, polycarbonate frame design
• Measuring tip:	• hardened steel, replaceable
• Read-Out:	• millimeters, fractional inches, decimal inches

20 HOFFMANN Dovetail Keys

HOFFMANN Dovetail Keys, medium brown plastic polymer

Order Number	Size	Size in mm	Packaging	material
W9000900	W0 - 3/8"	W0 - 10mm	1,000 pcs. carton	medium brown polymer
W9002200	W0 - 7/8"	W0 - 22mm	1,000 pcs. carton	medium brown polymer
W9003500	W0 - 1 3/8"	W0 - 35mm	1,000 pcs. carton	medium brown polymer
W9100600	W1 - 1/4"	W1 - 6.0mm	1,000 pcs. carton	medium brown polymer
W9101000	W1 - 3/8"	W1 - 10mm	1,000 pcs. carton	medium brown polymer
W9101400	W1 - 9/16"	W1 - 14mm	1,000 pcs. carton	medium brown polymer
W9101800	W1 - 3/4"	W1 - 18mm	1,000 pcs. carton	medium brown polymer
W9102200	W1 - 7/8"	W1 - 22mm	1,000 pcs. carton	medium brown polymer
W9103000	W1 - 1 3/16"	W1 - 30mm	1,000 pcs. carton	medium brown polymer
W9104000	W1 - 1 9/16"	W1 - 40mm	1,000 pcs. carton	medium brown polymer
W9105000	W1 - 2"	W1 - 50mm	1,000 pcs. carton	medium brown polymer
W9106000	W1 - 2 3/8"	W1 - 60mm	1,000 pcs. carton	medium brown polymer
W9206000	W2 - 1/4"	W2 - 6.0mm	1,000 pcs. carton	medium brown polymer
W9200900	W2 - 3/8"	W2 - 9.5mm	1,000 pcs. carton	medium brown polymer
W9201200	W2 - 1/2"	W2 - 12mm	1,000 pcs. carton	medium brown polymer
W9201400	W2 - 9/16"	W2 - 14mm	1,000 pcs. carton	medium brown polymer
W9201500	W2 - 5/8"	W2 - 15.8mm	1,000 pcs. carton	medium brown polymer
W9202000	W2 - 13/16"	W2 - 20.6mm	1,000 pcs. carton	medium brown polymer
W9202200	W2 - 7/8"	W2 - 22mm	1,000 pcs. carton	medium brown polymer
W9202500	W2 - 1"	W2 - 25.4mm	1,000 pcs. carton	medium brown polymer
W9203200	W2 - 1 1/4"	W2 - 32mm	1,000 pcs. carton	medium brown polymer
W9203800	W2 - 1 1/2"	W2 - 38mm	1,000 pcs. carton	medium brown polymer
W9204600	W2 - 1 13/16"	W2 - 46mm	1,000 pcs. carton	medium brown polymer
W9206000	W2 - 2 3/8"	W2 - 60mm	1,000 pcs. carton	medium brown polymer
W9301200	W3 - 1/2"	W3 - 12.7mm	1,000 pcs. carton	medium brown polymer
W9301500	W3 - 5/8"	W3 - 15.8mm	1,000 pcs. carton	medium brown polymer
W9301700	W3 - 11/16"	W3 - 17mm	1,000 pcs. carton	medium brown polymer
W9301900	W3 - 3/4"	W3 - 19mm	1,000 pcs. carton	medium brown polymer
W9302500	W3 - 1"	W3 - 25.4mm	1,000 pcs. carton	medium brown polymer
W9303100	W3 - 1 1/4"	W3 - 31.7mm	1,000 pcs. carton	medium brown polymer
W9303800	W3 - 1 1/2"	W3 - 38.1mm	1,000 pcs. carton	medium brown polymer
W9304600	W3 - 1 13/16"	W3 - 46mm	1,000 pcs. carton	medium brown polymer
W9305200	W3 - 2"	W3 - 52mm	1,000 pcs. carton	medium brown polymer
W9302600	W3 - 2 3/8"	W3 - 60mm	1,000 pcs. carton	medium brown polymer
W9308000	W3 - 3 1/8"	W3 - 80mm	1,000 pcs. carton	medium brown polymer
W9301000	W3 - 4"	W3 - 100mm	1,000 pcs. carton	medium brown polymer
W9404000	W4 - 1 9/16"	W4 - 40mm	100, 500, 1000 pcs.	medium brown polymer
W9406000	W4 - 2 3/8"	W4 - 60mm	100, 500, 1000 pcs.	medium brown polymer
W9408000	W4 - 3 1/8"	W4 - 80mm	100, 500, 1000 pcs.	medium brown polymer
W9401000	W4 - 4"	W4 - 100mm	100, 500, 1000 pcs.	medium brown polymer

HOFFMANN Dovetail Keys, white plastic polymer

W9206000-22	W2 - 1/4"	W2 - 6.0mm	1,000 pcs. carton	solid white polymer
W9200900-22	W2 - 3/8"	W2 - 9.5mm	1,000 pcs. carton	solid white polymer
W9201200-22	W2 - 1/2"	W2 - 12mm	1,000 pcs. carton	solid white polymer
W9201400-22	W2 - 9/16"	W2 - 14mm	1,000 pcs. carton	solid white polymer
W9201500-22	W2 - 5/8"	W2 - 15.8mm	1,000 pcs. carton	solid white polymer
W9202000-22	W2 - 13/16"	W2 - 20.6mm	1,000 pcs. carton	solid white polymer
W9202200-22	W2 - 7/8"	W2 - 22mm	1,000 pcs. carton	solid white polymer
W9202500-22	W2 - 1"	W2 - 25.4mm	1,000 pcs. carton	solid white polymer

21 HOFFMANN Dovetail Keys

HOFFMANN Dovetail Keys, white plastic polymer



W9203200-22	W2 - 1 1/4"	W2 - 32mm	1,000 pcs. carton	solid white polymer
W9203800-22	W2 - 1 1/2"	W2 - 38mm	1,000 pcs. carton	solid white polymer
W9204600-22	W2 - 1 13/16"	W2 - 46mm	1,000 pcs. carton	solid white polymer
W9206000-22	W2 - 2 3/8"	W2 - 60mm	1,000 pcs. carton	solid white polymer



W9301200-22	W3 - 1/2"	W3 - 12.7mm	1,000 pcs. carton	solid white polymer
W9301500-22	W3 - 5/8"	W3 - 15.8mm	1,000 pcs. carton	solid white polymer
W9301700-22	W3 - 11/16"	W3 - 17mm	1,000 pcs. carton	solid white polymer
W9301900-22	W3 - 3/4"	W3 - 19mm	1,000 pcs. carton	solid white polymer
W9302500-22	W3 - 1"	W3 - 25.4mm	1,000 pcs. carton	solid white polymer
W9303100-22	W3 - 1 1/4"	W3 - 31.7mm	1,000 pcs. carton	solid white polymer
W9303800-22	W3 - 1 1/2"	W3 - 38.1mm	1,000 pcs. carton	solid white polymer
W9304600-22	W3 - 1 13/16"	W3 - 46mm	1,000 pcs. carton	solid white polymer
W9305200-22	W3 - 2"	W3 - 52mm	1,000 pcs. carton	solid white polymer

HOFFMANN Dovetail Keys, "wood-match" polymer



W9201500-1041	W2 - 5/8"	W2 - 15.8mm	1,000 pcs. carton	light maple color
W9202200-1041	W2 - 7/8"	W2 - 22mm	1,000 pcs. carton	light maple color



W9201500-8011	W2 - 5/8"	W2 - 15.8mm	1,000 pcs. carton	maple color
W9202200-8011	W2 - 7/8"	W2 - 22mm	1,000 pcs. carton	maple color



W9201500-8041	W2 - 5/8"	W2 - 15.8mm	1,000 pcs. carton	cherry color
W9202200-8041	W2 - 7/8"	W2 - 22mm	1,000 pcs. carton	cherry color



W9201500-8065	W2 - 5/8"	W2 - 15.8mm	1,000 pcs. carton	walnut color
W9202200-8065	W2 - 7/8"	W2 - 22mm	1,000 pcs. carton	walnut color



W9201500-8003	W2 - 5/8"	W2 - 15.8mm	1,000 pcs. carton	dark walnut color
W9202200-8003	W2 - 7/8"	W2 - 22mm	1,000 pcs. carton	dark walnut color



W9201500-55	W2 - 5/8"	W2 - 15.8mm	1,000 pcs. carton	solid black
W9202200-55	W2 - 7/8"	W2 - 22mm	1,000 pcs. carton	solid black

HOFFMANN Dovetail Keys, solid hardwood



W8210000-CHE	W - 2 solid cherry	12" long	solid hardwood
W8210000-MAH	W - 2 solid mahogany	12" long	solid hardwood
W8210000-MAP	W - 2 solid maple	12" long	solid hardwood
W8210000-OAK	W - 2 solid oak	12" long	solid hardwood
W8210000-WAL	W - 2 solid walnut	12" long	solid hardwood
W8210000-WEN	W - 2 solid wenge	12" long	solid hardwood



W8310000-CHE	W - 3 solid cherry	12" long	solid hardwood
W8310000-MAH	W - 3 solid mahogany	12" long	solid hardwood
W8310000-MAP	W - 3 solid maple	12" long	solid hardwood
W8310000-OAK	W - 3 solid oak	12" long	solid hardwood
W8310000-WAL	W - 3 solid walnut	12" long	solid hardwood
W8310000-WEN	W - 3 solid wenge	12" long	solid hardwood



W8410000-CHE	W - 4 solid cherry	12" long	solid hardwood
W8410000-MAH	W - 4 solid mahogany	12" long	solid hardwood
W8410000-MAP	W - 4 solid maple	12" long	solid hardwood
W8410000L-OAK	W - 4 solid oak	12" long	solid hardwood
W8410000-OAK	W - 4 oak 3-ply	12" long	3-ply laminated
W8410000-WAL	W - 4 solid walnut	12" long	solid hardwood
W8410000-WEN	W - 4 solid wenge	12" long	solid hardwood

22 HOFFMANN Dovetail Key Sample Cases

Dovetail Key Sample Cases are intended to give product designers, machine operators, workshop personnel and frame assemblers a “hands-on” overview of all available Dovetail Keys in a given size. Enough Keys are included to produce a few corner samples and even complete frames for product testing.

Part Number: W9000111

W-1 Hoffmann Dovetail Key Sample Case is a sturdy, securely latching plastic case with approx. 20 pieces each of all W-1 Dovetail Keys. Inside label clearly indicates each Key size with dimension and part number. Case contains approx. 180 Keys.



Part number: W9000222

W-2 Hoffmann Dovetail Key Sample Case is a sturdy, securely latching plastic case with approx. 20 pieces each of all W-2 Dovetail Keys. Inside label clearly indicates each Key size with dimension and part number. Case contains approx. 255 Keys.



Part Number: W9000333

W-3 Hoffmann Dovetail Key Sample Case is a sturdy, securely latching plastic case with approx. 20 pieces each of all W-3 Dovetail Keys. Inside label clearly indicates each Key size with dimension and part number. Case contains approx. 175 Keys.



Tip: Be sure to order matching router bits!

23 Troubleshooting

Problem	Possible Causes	Solution
Motor does not start when lever is pulled.	Motor is not switched on	Set motor switch to ON
	Power supply is interrupted	Check to make sure power cord is securely plugged in, check extensions cords, check fuses/breaker in line with wall outlet.
	Motor is overheated	Unplug motor until it has cooled down.
Decreasing RPM (motor speed)	Router bit is dull or broken.	Replace router bit with Original HOFFMANN bit.
	Material being processed is too hard.	Only process material listed under heading 3 – page 6
	Motor brushes are worn or damaged.	Replace brushes with Original HOFFMANN brushes
Difficulty or resistance when raising router carriage up.	Air pressure too low	Set incoming air supply to 90 psi
	Height Adjustment Bar is set and locked at "0"	Set height adjustment bar to desired height.
Difficulty inserting Dovetail Keys Dovetail Keys slide into keyway too easy	Motor and router bit projection setting incorrect.	Adjust motor and/or router bit as shown under heading 11 and 12
Keyway position offset on left and right side workpiece (square or butt joints)	Square Stop and/or Flip Stops are not set correctly.	Adjust stops for proper alignment.
Keyway position offset on miter joint	Miter cut not precisely 45 degree on one or both parts	Check and adjust miter saw – all four parts for a frame must fit perfectly without Dovetail Keys.
	Material was not properly placed on machine	Make sure table is free of dust and material is placed tightly against fences.
	Material was not properly held during routing operation	Hold material steady to keep it from moving during routing operation
	Motor not installed correctly	Motor must be installed all the way in motor carriage – follow instructions under heading 11

Please contact Hoffmann Technical Support at any time with any questions, concerns or other issues. We are here to help you get the most out of your Hoffmann Dovetail Joining Machine.



Toll-free: 866 – 248 – 0100

International: 001 – 828 – 430 – 4510

Email: Info@Hoffmann-USA.com

24-a Machine Drawings and Parts Lists

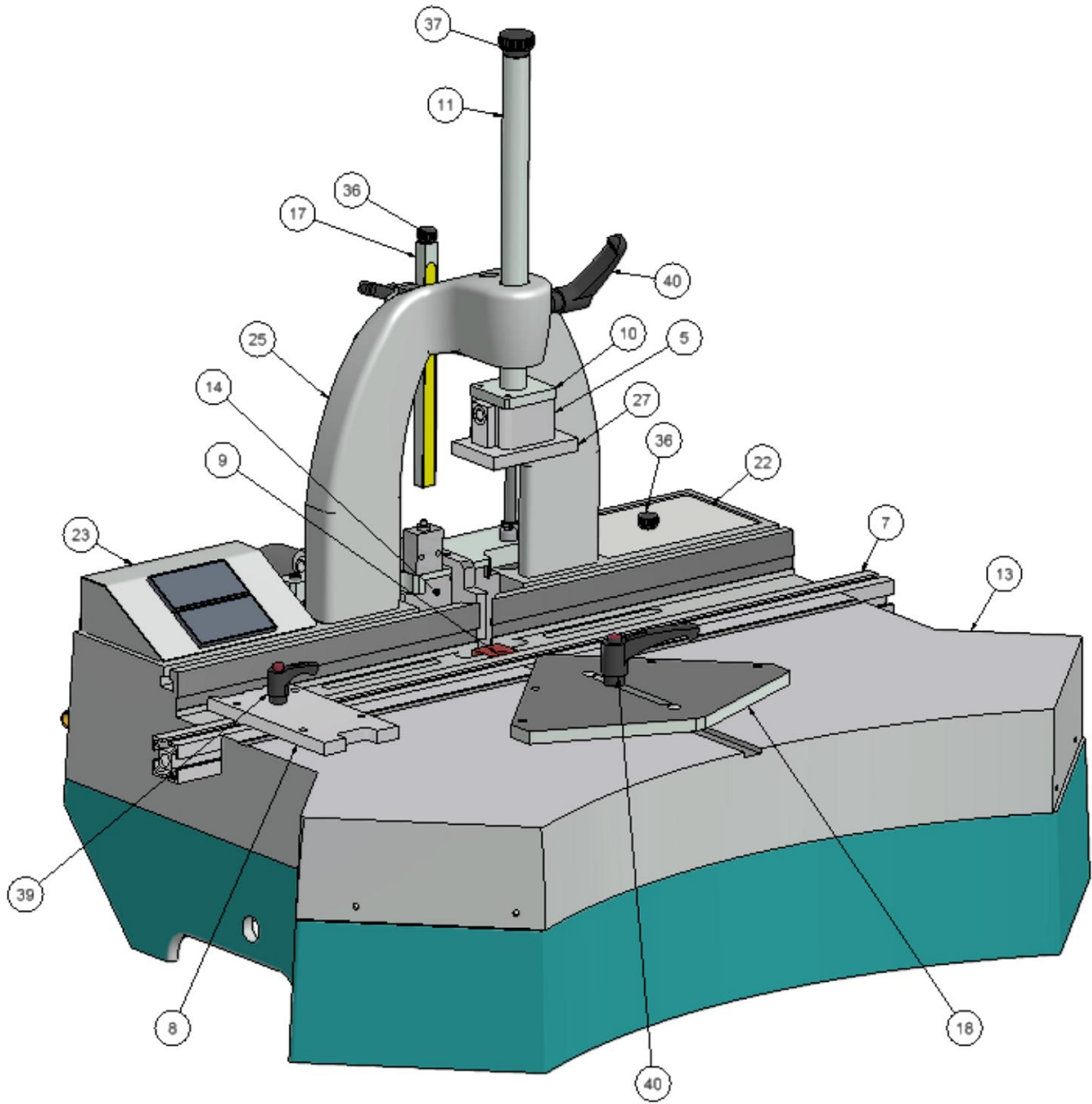

24-b Machine Drawings and Parts Lists

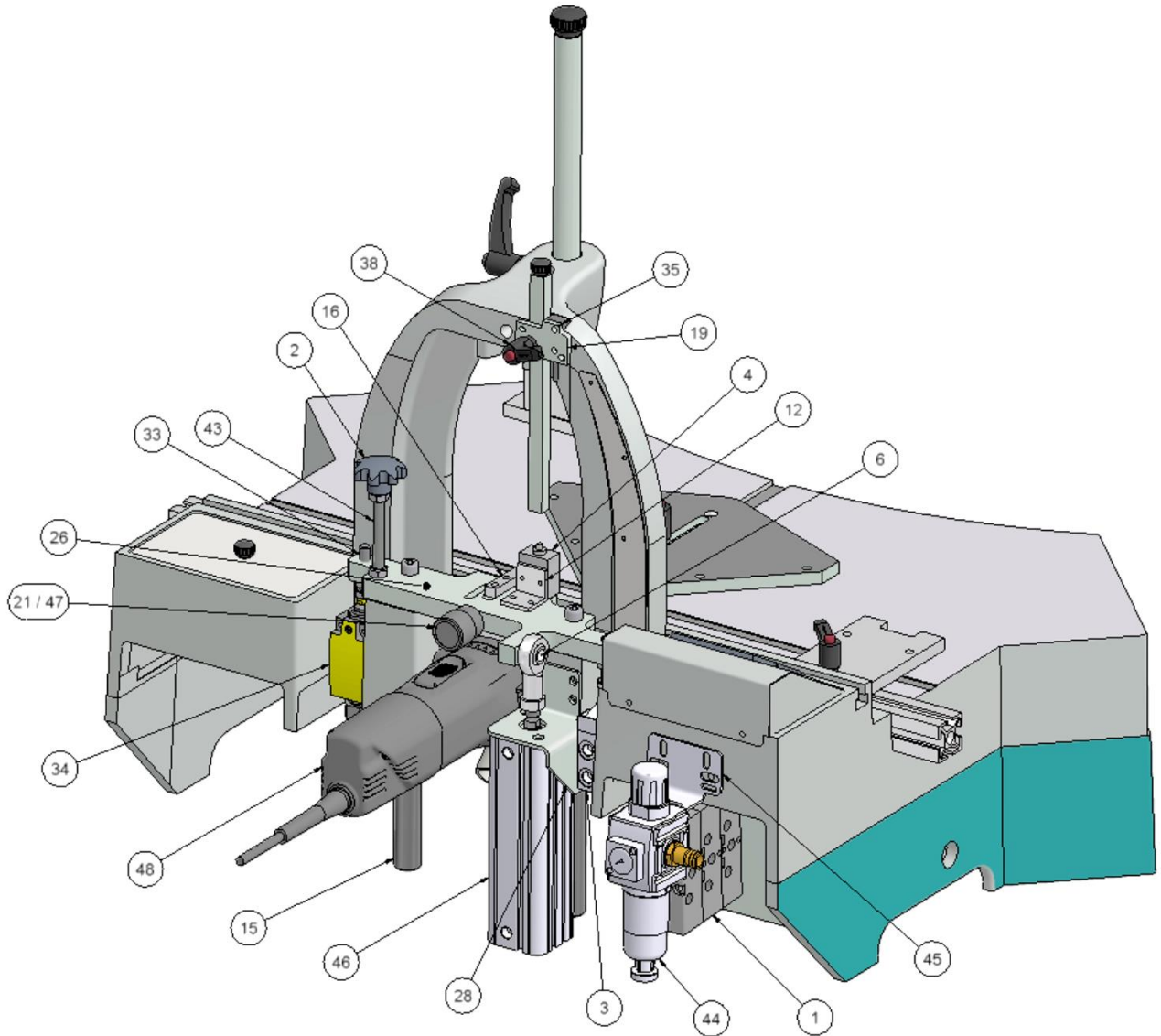

24-c Machine Drawings and Parts Lists

Pos	Part Number	Description	Qty.
1.1	HP 0820230002	Pneumatic Valve, 5/2, spring return	1
1.2	HP 0820230003	Pneumatic Valve, 5/2	1
1.3	HP 0821000004	Pneumatic Shuttle Valve	1
2	06220-208	Star handle, M8	1
3	HP 0820402002	Pneumatic Valve with roller lever	1
4	HP 0820408001	Pneumatic Valve with pin plunger	1
5	HP 0822406341	Pneumatic hold-down cylinder, 32-10	1
6	HP 1822124003	Ball Joint, M10x1,25	1
7	200009-00-4	Recessed Fence Rail-30-30-680	1
8	W3020001	Square Stop – MU3	1
9	W2000015	Chip Breaker, square	1
10	200101-00-4	Cylinder Mounting Plate	1
11	200102-01-4	Support Rod, material clamp cylinder	1
12	200108-00-4	Mounting Bracket – pn. valve	1
13	7.205.00.01-02	Base Casting and Table Unit – MU3	1
14	7.205.00.04-02	Motor Bracket – MU3	1
15	7.205.00.09	Precision Guide Rods D20h6x226-M8	2
16	7.205.00.10-01	Center Line Locator – MU3	1
17	7.205.00.12-02	Height Adjustment Bar – MU3	1
18	W3060001	Fence Plate, 45 degr, - MU3	1
19	7.205.00.17-03	Cover Plate – height adjustment bar	1
20	7.205.00.18-01	Bracket for sensor	1
21	7.205.00.19	Motor Adjustment Spindle	1
22	7.205.00.21	Cover Plate	2
23	7.205.00.22-01	Digital Display, complete unit	1
24	7.205.00.24-02	Dust Collection Port Assembly	1
25	7.205.100.02-02	Arch Casting – MU3-P	1
26	7.205.100.03-03	Motor Carriage Plate - MU3-P	1
27	7.205.100.06-01	Material Hold Down Plate – MU3-P	1
28	7.205.100.18-01	Cylinder Mounting Bracket	1
29	7.205.100.23	Wire Cover	1
30	7.205.100.24	Valve Bracket	1
31	DIN 912 - M6 x 25	Allen-head Bolt	1
32	DIN 912 - M8 x 30	Allen-head Bolt	2
33	DIN 933 - M8 x 35	Hex-head Bolt	2
34	EATON_LS11-S	Limit Switch with Plunger	1
36	K0110.005X10	Knurled Knob – cover plate	3
37	K0247.208X20	Knurled Knob – support rod	1
38	K0269.71105x20	Lever Handle M5	1
39	K0269.71106x30	Lever Handle M6	1
40	K0269.71208x30	Lever Handle M8	2
41	DIN 934 - M8	Hex Nut	4
42	LME-20	Linear Bearing LME20	4
43	M8-100	Threaded Rod M8-L100mm	1
44	R412014645	Pressure Regulator Assembly AS1	1
45	R412014755	Mounting Bracket AS1	1
46.1	R422001245	Pneumatic Main Cylinder D32-H125	1
46.2	R412010569	Flow Control Valve (installed at cylinder)	2
47	GN 626-27-B6-S	Fine Adjustment Knob	1
48	W3900046	Hoffmann router motor 120 volt –885w	1
49	XXXX	Hoffmann dovetail router bit	1

Note all listed parts may be visible on machine drawings. Machine design is subject to change.

26 Terms and Conditions of Sale and Warranty

1. Application and Scope:

The terms and conditions contained herein apply to proposals made, and to purchase orders received, by HOFFMANN MACHINE COMPANY, INC. (hereinafter called "Seller"), and sets forth the entire agreement between the parties hereto, and supersedes all communication, representations or agreements, whether oral or written, between the parties hereto with respect to the subject matter herein, and no agreement or understanding varying or extending the terms or conditions hereof will be binding unless expressly agreed to in writing by Seller. No conditions stated by Buyer in its purchase order or orders shall be binding upon Seller if in conflict with, inconsistent with, or in addition to, the terms and conditions contained herein, unless expressly accepted in writing by Seller. Seller's failure to object to any provision contained in any communication or purchase order from Buyer shall not be deemed a waiver of the terms and conditions herein. All orders or contracts are subject to approval and acceptance by Seller at its main office in North Carolina. These Terms and Conditions are within the sole discretion of Seller and are subject to change with or without prior notice.

2. Quotations and F.O.B. Point:

Prices are quoted and all sales are made F.O.B. Seller's facility and, unless otherwise indicated in the proposal, prices quoted are effective for a maximum thirty (30) days after the date of any proposal.

3. Terms of Payment:

All invoices are due and payable as set forth on the front of the invoice. Each delivery shall be considered a separate and independent transaction and payment thereof shall be made on terms set forth on invoice covering same. If delivery is delayed by Buyer, payment shall become due when Seller is prepared to make delivery. If, in the sole judgment of the Seller, the financial condition of Buyer at any time does not justify continuation of manufacture or of delivery as originally specified, Seller may vary terms of payment by requiring full or partial payment in advance, or otherwise, or may ship to Buyer's order against sight draft with bill of lading attached.

If payment is not received on or before payment due date and as set forth in terms on proposal and/or invoice, or if payment is delayed, or if payment amount is reduced, seller reserves the right to reduce or revoke equipment warranty, at seller's sole discretion. Eventual payment of outstanding amount does not automatically reinstate warranty. Warranty can only be reinstated by seller and reinstatement must be confirmed by seller in writing to be valid.

4. Taxes:

Unless the quotation expressly provides otherwise, the amount of any present or future Federal, State or local sales, excise or other tax applicable to the products purchased hereunder, or to the manufacture or sale thereof (including, without limitation, state or local privilege or excise taxes based on gross revenue), and any taxes or amounts in lieu thereof paid or payable by Seller in respect of the foregoing (excluding, however, taxes based on net income), shall be added to the purchase prices and shall be paid by Buyer. In lieu thereof, Buyer may provide Seller with an appropriate tax exemption certificate acceptable to the taxing authorities.

5. Warranty:

The products covered herein are warranted, for a period of twelve (12) months from date of shipment, against defects in material and workmanship under normal use and service by Buyer. The liability of Seller under its warranty is limited to adjustment, in accordance with the Warranty Adjustment Terms set forth below, for products which are found to be defective by Seller in the form in which they were originally shipped. In no event will Seller be liable for collateral, consequential or other damages of any kind.

Parts replaced under Warranty are covered for a period of six (6) months from the date of shipment, unless otherwise specified on invoice, subject to the warranty adjustment terms set forth below.

SELLER MAKES NO OTHER WARRANTIES, EXPRESS OR IMPLIED, INCLUDING WARRANTIES OF MERCHANTABILITY OR FITNESS FOR A PARTICULAR PURPOSE.

6. Warranty Adjustment Terms:

(a) Adjustments will be limited to claims which are presented promptly after the product is found to be defective, and within the aforesaid warranty period.

(b) All products claimed to be defective will be subject to inspection and test by Seller. Normally, Seller will request return of products for inspection and test, however, Seller reserves the right to make inspection and test on Buyer's premises. Returns are to be made only as and if authorized in writing by Seller.

(c) Buyer will pay all packaging, inspection, labor and transportation costs involved. Credit for the transportation costs only will be issued by Seller provided adjustment subsequently is allowed.

(d) No adjustments will be allowed for products which have been subjected to abuse, improper installation or application, alteration, accident or negligence in use, storage, transportation or handling; nor for products on which original identification markings have been removed, defaced or altered.

(e) Final determination as to whether any adjustment is allowable, and as to the extent thereof, rests with Seller. Full adjustment, if allowed, normally will be made by replacement in kind on an exchange basis. Pro rate adjustment, if allowed, normally will be made by the issuance of credit. In all cases, however, Seller reserves the right to make adjustment by repair, replacement or credit.

(f) Replacement for products found subject to adjustment, whether new or repaired, will be shipped F.O.B. city of destination with transportation charges prepaid by Seller.

7. Installation:

Buyer shall install machinery purchased from Seller at Buyer's cost and expense, unless otherwise expressly stipulated in writing.

8. Packaging and Shipment:

All products shipped hereunder will be packaged in accordance with standard commercial practice for domestic shipment. Seller's liability as to delivery ceases upon making delivery of products purchased hereunder to carrier at Seller's facility, in good condition, the carrier acting as Buyer's agent. All claims for damages must be filed with the carrier or Buyer's insurer as appropriate. Seller will select the method of shipment unless Buyer does so in writing at least ten (10) days in advance of the scheduled delivery date. Equipment held for Buyer because of Buyer's delay in acceptance, shall be at Buyer's risk and expense. Seller does not assume liability for shipping in the least expensive manner.

9. Deliveries:

It is the desire of Seller to meet requested delivery schedules, however, Seller shall not incur any liability, consequential, collateral or otherwise, due to any delay or failure to deliver for any reason, other than arbitrary refusal by Seller to perform. Any delivery indication furnished by Seller only represents the best estimate of the time required to make shipment.

10. Assignment:

Buyer shall not assign this purchase order or any interest herein or any rights thereunder, without the prior written consent of Seller

11. Termination:

Seller may terminate the purchase order or any part thereof herein referred to or any other purchase order or orders then outstanding by written, telegraphic or electronic mail notice to Buyer if Buyer becomes insolvent or is subject to proceedings under any law relating to bankruptcy, insolvency or relief of debtors. Upon such termination Seller shall be entitled to receive reimbursement for reasonable termination charges.

12. Cancellations or Returns:

Buyer shall not cancel any order nor return any equipment without first obtaining the written consent of Seller. In any event, in case of refusal or inability of Buyer to accept a delivery, the Buyer shall nevertheless be liable for freight, express, storage, handling, restocking and any other expense resulting. In no event are orders for machines or parts built to customers' specification subject to cancellation and Buyer shall be liable for work done and materials used.

13. Specifications:

(a) Phone order specifications are filled at Buyer's risk unless confirmed in writing prior to commencement of manufacture.

(b) If equipment is found not to meet original specifications, Seller shall have a reasonable time to make adjustments.

14. Law Governing:

Buyer's purchase order shall be governed by and construed according to the laws of the State of North Carolina. The courts of the State of North Carolina shall have jurisdiction over any controversy that may arise out of the dealings between Buyer and Seller.

15. Force Majeure:

Seller shall not be liable under this agreement by reason of its delay in the performance of or failure to perform any of its obligations hereunder if such delay or failure is caused by acts of God or the public enemy, riots, incendiaries, interference by civil or military authority, compliance with government laws, rules and regulations or any fault beyond its control.

16. Acceptance:

Payment for or a deposit made for the products shall constitute a contract embodying all of terms and conditions stated herein.

17. Ownership:

All products remain the sole property of the Seller until all charges, including all transportation, crating and installation costs, are paid in full.

18. Severability:

The provisions of these Terms and Conditions are intended to be severable. If, for any reason, any of the above provisions should be found unenforceable or invalid in whole or in part, in any jurisdiction, such provision be ineffective only to the extent the determination of invalidity or unenforceability in that jurisdiction. Any such determination shall not affect the enforceability or validity of the remaining provisions.

This manual was created to the best of our knowledge at time of writing – subject to future updates.