



Alfamacchine

A Fletcher Company

EN

INSTRUCTIONS MANUAL



T-300
Pneumatic Double Mitre Saw

T-350
Pneumatic Double Mitre Saw

T-400
Pneumatic Double Mitre Saw

Name	DOUBLE MITRE SAW FOR "V" CUTTING
Function	45° CUTTING OF MOULDINGS MADE FROM WOOD, ENGINEERED WOOD AND SIMILAR, HARD PLASTIC AND LIGHTWEIGHT ALLOYS
Model / Type	T300/T350/T400
Serial number	
Year of construction	
Manual Revision	01

PLEASE RETAIN FOR FUTURE REFERENCE



Alfamacchine S.r.l.
Via Curie M. e P., 3
47122 Forlì - Italy

EC DECLARATION OF CONFORMITY

The Manufacturer
with registered offices in

Alfamacchine S.r.l.
Via Curie M. e P., 3
47122 Forlì - Italy
Tel. +39. 0543.783301

under its own responsibility,
that the machine:

HEREBY DECLARES,

Name: DOUBLE MITRE SAW FOR "V" CUTTING

Function: PICTURE FRAMING, FURNITURE COMPONENTS, WINDOW FRAMES AND
DOORS, FRAMEWORK IN GENERAL

Model: **T300-T350-T400**

Type: PNEUMATIC

Serial number:

COMPLIES WITH THE PROVISIONS LAID DOWN IN THE FOLLOWING DIRECTIVES:

- Machinery Directive 2006/42/EC
- Electromagnetic Compatibility (EMC) Directive 2014/30/EU

REFERENCE TO HARMONIZED STANDARDS APPLIED:

EN ISO 12100:2010; EN 60204-1:2006; UNI EN 1870-16:2012

Alfamacchine S.r.l., in observance of art. 12, paragraphs 3 and 4 of Machinery Directive 2006/42/EC, has applied the EC type-examination procedure c/o the following notified body:

NOTIFIED BODY no. 0476
KIWA CERMET ITALIA S.p.a.
Via Cadriano, 23
40057 - GRANAROLO DELL'EMILIA (BO)

EC-type examination certificate no. C15E355
And authorizes

.....**Alfamacchine S.r.l.**
Via Curie M. e P., 3
47122 Forlì (FC)

TO COMPILE THE TECHNICAL FILE ON ITS BEHALF

Forlì ,

Date

The Manufacturer

EN TRANSLATION OF THE ORIGINAL INSTRUCTIONS

INDEX

1.	INTRODUCTION TO USE	2
1.1.	HOW TO CONSULT THIS MANUAL AND THE SYMBOLS ADOPTED	2
1.3.	TYPE OF USE AND CONTRAINDICATIONS	5
1.4.	TECHNICAL CHARACTERISTICS	7
1.5.	PRODUCTS PROCESSED - HANDLED OR GENERATED	7
1.6.	EMISSION OF AIRBORNE NOISE	8
1.7.	SAFETY INSTRUCTIONS	8
1.7.1.	RESIDUAL RISKS	8
1.7.2.	DANGERS	9
1.8.	DESCRIPTION OF SAFETY FUNCTIONS	10
1.9.	MACHINE DESCRIPTION	12
1.10.	MAIN MACHINE COMPONENTS	12
2.	INSTALLATION	16
2.1.	STORING	16
2.2.	CHECKS ON RECEPTION	16
2.3.	TRANSPORT, LIFTING AND HANDLING	17
2.4.	LIFTING AND HANDLING	17
2.5.	REMOVING THE PACKAGING	19
3.	PRELIMINARY PREPARATION AND ADJUSTMENT PROCEDURES	20
3.1.	POSITIONING	20
3.2.	SECURING THE MACHINE TO THE FLOOR	20
4.	INITIAL START-UP AND USE OF THE MACHINE	24
4.1.	WORKSTATIONS AND OPERATORS' TASKS	24
4.2.	CHECKS, ADJUSTMENTS AND START-UP	24
4.3.	START-UP	25
5.	MAINTENANCE, TROUBLESHOOTING AND CLEANING	32
5.1.	MAINTENANCE TECHNICIAN REQUIREMENTS	32
5.2.	WORK STATIONS AND MAINTENANCE TECHNICIAN DUTIES	32
5.3.	MAINTENANCE PRESCRIPTIONS	32
5.4.	GENERAL WARNINGS	32
5.6.	ROUTINE MAINTENANCE	33
5.6.1.	TASKS THAT CAN BE PERFORMED BY THE OPERATOR	34
5.6.2.	TASKS THAT CAN BE PERFORMED ONLY BY MAINTENANCE TECHNICIANS	35
	Blade replacement	36
	Cutting angle adjustment	37
	Blade positioning	37
	Checking the vertical angle of the blades	37
	Checking, adjusting the tension and replacing the belt	38
	Condensate drainage from tanks	40
	Check the vertical stoppers for wear	41
	Checking the horizontal stopper (optional) for wear	41
	Checking the internal stopper (optional) for wear	41
	Replacing the central Teflon support	42
	Check the oil level in the pneumatic unit	42
	Lubricator adjustment	42
5.6.3.	CLEANING	43
	Stem lubrication (by the maintenance technician)	46
	Grease nipple lubrication (by the maintenance technician)	46
6.	TROUBLESHOOTING AND RELEASE OF MOVING PARTS	47
7.	REINSTALLATION AND REUSE	48
8.	INSTRUCTIONS FOR EMERGENCIES	49
9.	SCRAPPING AND DISPOSAL	49
9.1.	SCRAPPING	49
9.2.	DISPOSAL	50
	PNEUMATIC DIAGRAM	51
	ELECTRICAL DIAGRAM	52
	ELECTRICAL SYSTEM ON BOARD THE MITRE SAW MACHINE	53

 **DANGER - WARNING**
BEFORE USING THE MACHINE PLEASE READ THIS MANUAL CAREFULLY SO THAT YOU BECOME FAMILIAR WITH THE MACHINE, ITS ENVISAGED USE AND ANY RISKS ASSOCIATED WITH IT.

Keep the Use and Maintenance Manual in good condition: Remember, it is an integral part of the machine. Always refer to the manual to get best machine performance in maximum safety while performing the operations described therein.
This manual must be kept in an easily accessible place, near the machine, at all times so that it can be consulted whenever necessary.

 **DANGER - WARNING**
USE THE MACHINE SOLELY AND EXCLUSIVELY FOR THE USES INDICATED AND IN ACCORDANCE WITH THE RECOMMENDATIONS PROVIDED IN THIS MANUAL. NEVER TAMPER WITH IT, FORCE IT OR USE IT IN ANY INAPPROPRIATE MANNER.

1. INTRODUCTION TO USE

1.1. HOW TO CONSULT THIS MANUAL AND THE SYMBOLS ADOPTED















Please pay particular attention to the words "DANGER – WARNING", "DANGER – CAUTION" and "NOTE" as used in this manual. To draw the user's attention to certain information and provide warning messages, the operations described in this manual are accompanied by symbols and notes to highlight the presence of any hazards and indicate the safe use of the equipment. These symbols and notes belong to various categories, as indicated below:





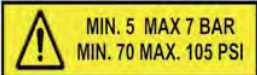



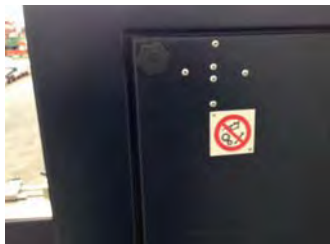

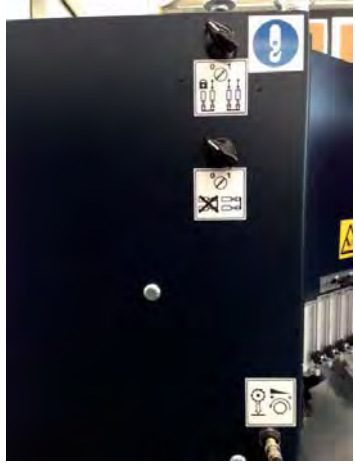
 **DANGER – WARNING: IMPORTANT INFORMATION CONCERNING GENERAL SAFETY.**

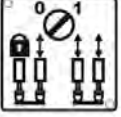
 **DANGER-CAUTION: *highlights situations where careful and sensible actions are essential.***

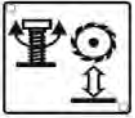
 **NOTES: *information of a technical nature.***

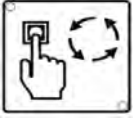
1.2. WARNING STICKERS - INDICATIONS (see figure)

DECAL	DESCRIPTION	LOCATION
	Wear protective goggles.	
	Wear protective gloves.	
	Wear safety footwear	
	Wear protective safety glasses	
	Wear a mask to protect the respiratory tract	
	Consult the instruction manual	
	Hand crushing hazard.	
	Cutting hazard	
	Blades dataplate	
	Isolate the energy source	
	Working pressure	
	Horizontal clamp command pressure adjustment	
	Vertical clamp command pressure adjustment	
	It is prohibited to perform maintenance operations on moving parts.	

DECAL	DESCRIPTION	LOCATION
	Lifting points	
	Horizontal clamp activation/deactivation	
	Single vertical/double clamp activation	
	Blade descent speed adjustment	
	Blade height adjustment	
	Two-hand cycle start button	
	Safety warning on machine use	
	EC dataplate	

1.3. TYPE OF USE AND CONTRAINDICATIONS.

PERMITTED USE

The machine described herein is designed to be run by 1 operator suitably trained and instructed with regard to residual risks. The operator must have the same skills, in terms of safety, as the maintenance technicians and adequate professional competence.

- This machine is a double mitre saw for "V" cuts designed to cut 45° mitres for picture frames, furniture components, doors and windows and framework in general made from wood, engineered wood or similar, hard plastic and lightweight alloys.
- The machine has been designed and built for indoor industrial use.

UNINTENDED USE



DANGER - WARNING

THE MACHINE MUST NOT BE USED IN A PROHIBITED MANNER. SPECIFICALLY:

- it cannot be operated with parameters different to those shown in the "TECHNICAL CHARACTERISTICS" table or with products and/or materials with different characteristics to those previously described in the heading "TECHNICAL CHARACTERISTICS".
- all uses of the machine other than those described in this manual are construed as improper and as such the manufacturer declines all liability.
- the user is responsible for any damage resulting from failure to observe the operating conditions agreed at the time of technical specification and order confirmation.

FORBIDDEN USE



DANGER - WARNING

FURTHERMORE IT IS PROHIBITED TO USE THE MACHINE IN AN INCORRECT MANNER, IN PARTICULAR:

- never use flammable, corrosive or toxic substances to clean the machine,
- never allow unauthorized personnel to use the machine,
- never smoke or use open flame equipment or handle incandescent material, unless adequate safety measures have been adopted,
- never hang objects or weights on the machine,
- never use the machine with the safety guards open, incorrectly fastened, or removed,
- when using a torque wrench, never use extensions
- never use the machine with the safety devices and interlocking safety devices inhibited and, in general, with any safety and/or protective device (mechanical) deactivated and/or non-functional,
- never partially or totally by-pass, remove, modify or in any way render ineffective the guards, safety devices and warning signs,
- use of the machine is forbidden when the user has not adopted all the necessary measures to eliminate the residual risks as indicated in this instruction manual,
- never use the machine for operations other than those explicitly indicated in this instruction manual,
- never use the machine in environments for which it has not been designed unless all necessary safety measures have been adopted beforehand,
- the machine must not be used by untrained personnel
- foodstuffs must not be brought into contact with the machine,
- it is prohibited to activate the control devices for machine movements without first checking and ascertaining the absence of persons in the danger areas subject to machine movements,
- it is prohibited to enter the operating / danger zone of the machine during control of the machine's moving parts,
- it is prohibited to enter the machine working area with any part of the body, hands and arms included, before hazardous moving elements have come to a complete standstill.
- it is prohibited for the machine operator and maintenance technician to enter the danger zones to perform cleaning, lubrication, maintenance operations etc. without having first set the power cut-off switches to "ZERO" and padlocked them in this position,
- the machine must not be used in critical conditions of stability, i.e.:
 - when placed on a support surface which is not perfectly horizontal and smooth, or does not have an inadequate load capacity as indicated in this manual,
 - outdoors or worksites with open windows and doors,
- the following are strictly prohibited:
 - processing of materials and products that are not expressly indicated in the present manual,
 - working with materials which emit hazardous or harmful substances during processing



DANGER – CAUTION

The manufacturer cannot be held liable for any faults caused by unreasonable, improper and/or incorrect use of the machine.

The user is anyway responsible for all damage deriving from failure to comply with the specified terms of use. For any further information always consult the manufacturer's engineering department.

The user is always responsible for providing suitable personal protective equipment to machine operators and for informing them on the permissible uses of the machine.

PERSONNEL AUTHORIZED TO USE THE MACHINE

This machine has been designed and manufactured to be used by qualified personnel with adequate training, experience and skills in accordance with the characteristics described below:

Operators / Apprentices:

- may be male or female
- must be aged 18 or over
- must be aged 65 maximum
- must have full use of both hands
- must have no physical or mental disabilities
- must be adequately trained.
- must know and fully understand the contents of the user manual.

PERMITTED AMBIENT CONDITIONS AND OPERATING LIMITS

 **DANGER - WARNING**
THIS MACHINE IS NOT SUITABLE FOR USE IN POTENTIALLY EXPLOSIVE ENVIRONMENTS.
THEREFORE IT IS PROHIBITED TO INSTALL OR USE IT IN ANY SUCH ENVIRONMENT.

SERVICE CONDITIONS

SERVICE CONDITION	USER LIMITS
Installation type	Indoor
Floor conditions	Horizontal and smooth: irregularity and gradient tolerance within 2%
Supporting surface characteristics	Flooring in compliance with health and safety requirements in the workplace in accordance with all applicable legislation
Maximum ambient air temperature	+40°C
Minimum ambient air temperature	5°C (if the electrical equipment as a protection rating of at least IP54) 0°C (if the electrical equipment has a protection rating lower than IP54)
Ambient working temperature	+5 °C < T < +45 C
Transport and storage temperature	between -25°C and +55°C (temperatures of up to +70°C are admissible for periods of less than 24 h)
Maximum altitude above sea level	1000m
Minimum required light intensity	500 lux

1.4. TECHNICAL CHARACTERISTICS

Machine characteristics

Machine height	1700 mm/66.93 in
Machine length, side extensions included	3200 mm/125.98 in
Machine width.....	830 mm/32.68 in
Height of the working bench from the floor.....	950 mm/37.40 in
2 motors power.....	1.5 kW
Absorbed power	3 kW
Three-phase electrical power supply.....	400V/230V
Extractor inlets (diameter)	80 mm/ 3.15 in
Approximate weight.....	500 Kg / 1102.31 lbs

Minimum characteristics of the extractor system (not supplied)

Three-phase motors power	1.5 kW
Filtering surface	2.2 mq
Suction capacity	3.000 m ³ /h

Three-phase electrical power supply

Three-phase power supply voltage	400V
Frequency.....	50 Hz
Current.....	8 A
Phases.....	3 Ph
Auxiliary circuits voltage	24 AC
Absorbed power	3 kW



NOTE – For further information, consult the electrical diagram

Compressed air supply

Operating pressure.....	5 / 7 bar
Minimum pressure.....	5 bar.
Maximum pressure.....	8 bar.
Pressers cylinders pressure (MIN/MAX)	1.5/4 bar
Rated consumption.....	15 NL/cycle

1.5. PRODUCTS PROCESSED - HANDLED OR GENERATED

The products processed by the machine described herein must be mouldings for picture frames, furniture components, windows and doors and framework in general made from wood, engineered wood or similar, hard plastic, lightweight alloys, etc..

The main technical characteristics of the products handled by the machine described herein are provided below.

Profile characteristics

	T300	T350	T400
Profile height (min./max.)	10/60 mm 0.39/2.36 in	10/80 mm 0.39/3.15 in	10/80 mm 0.39/3.15 in
Blade external diameter	300 mm 11.81 in	350 mm 13.78 in	400 mm 15.75 in
Blade internal diameter	30 mm 1.18 in		
Blade thickness (MIN/MAX)	3.5/4 mm 0.13/0.16 in		
No. of blades	2		
Blade speed	3000 rpm		
Blade stroke	250 mm 9.84 in	275 mm 10.83 in	300 mm 11.81 in
Max. cutting height	80 mm 3.15 in		
Max. cutting width	60 mm 2.36 in	80 mm 3.15 in	100 mm 3.94 in



NOTE – The blades used must:

- be compliant with standard **EN 847-1** and designed to reduce noise emissions;
- only be those with a maximum permitted speed which exceeds the rotation speed of the blade-holder shaft;
- correctly sharpened.

1.6. EMISSION OF AIRBORNE NOISE

 **NOTE** – The manufacturer declares, under his own responsibility, that the machine produces a continuous equivalent A-weighted sound pressure level of 92.9 dB.

 **NOTE** – The values indicated are emission levels and do not necessarily safe levels of occupational exposure. Although there is a correlation between emission levels and exposure levels, this cannot reliably be used to determine whether or not additional precautions are necessary. The factors that influence the actual noise level to which the workforce is exposed include the characteristics of the operating environment and other noise sources, etc., i.e. the number of adjacent machines and other processes. The permitted exposure level may vary from country to country. In any case, this information allows the machine user to perform better danger and risk assessment.

 **DANGER – WARNING:**
TO AVOID THE DANGER OF HEARING DAMAGE CAUSED BY SHRILL OR INSISTENT NOISE, THE MACHINE OPERATOR AND MAINTENANCE TECHNICIAN MUST ALWAYS USE APPROPRIATE HEARING PROTECTION, SUCH AS HEARING DEFENDERS OR EARPLUGS.

1.7. SAFETY INSTRUCTIONS

This manual contains a list and description of the residual risks that could not be eliminated in the design stage and that therefore remain present on the machine.

For each risk, suitable instructions or prescriptions are given which the user must observe in order to avoid hazards affecting the machine operator, maintenance technicians, any exposed persons and the machine itself.

1.7.1. RESIDUAL RISKS

PPE to be used:

	Ear defenders
	Protective gloves
	Safety footwear
	Overalls to protect the body
	Mask to protect the respiratory tract

Residual risk of cutting and severing

Exercise maximum caution during the work phases. Consequently, said operations must only be carried out by expert, authorized personnel wearing appropriate PPE (protective gloves).

Residual risk of perforation and/or puncture wounds

Exercise maximum caution when performing maintenance or cleaning operations. Consequently, said operations must be carried out with the machine in safety conditions and disconnected from the power supplies, by expert, authorized personnel only, wearing appropriate PPE (protective gloves).

1.7.2. DANGERS

Hazards linked to the machine are indicated below:

Noise hazard

The user is advised to perform risk assessment for noise emissions in the location of machine installation and use, in accordance with the prescriptions set out by the relative legislation in force. Operators must therefore wear appropriate PPE to protect hearing during machine operation, control and inspection activities.

Crushing hazard

This hazard is present in the area where the clamping devices are activated.

Consequently operators and maintenance technicians, as well as observing the instructions provided in this manual, must never place their fingers or any other body part anywhere near the clamping devices.

Entanglement, drawing in and entrapment hazard

What's more, the operator must never wear rings, wrist watches, jewellery, torn clothing, scarves, ties or any other loose clothing or personal accessories that may constitute a risk. Make sure sleeves fit snugly around wrists and keep long hair tied back.

Fire hazard caused by excessive dust deposits.

Clean the external surfaces of the machine and surrounding parts to prevent dust deposits from building up.

It is the user's responsibility to establish a maintenance plan which includes periodical removal of dust.

Electrocution hazard

There is a residual risk of electrocution for the electrical equipment maintenance technician, whenever he has to work inside the electrical enclosures, junction boxes or on electrical components in the presence of live voltage for the purpose of carrying out inspections, maintenance and operating tests which require interventions with the electrical equipment powered and/or with the guards removed. Consequently maintenance electricians must work with extreme caution and observe the indications provided on the decals affixed near the aforementioned components.

Furthermore, interventions which require access into the aforementioned areas must be performed solely and exclusively by expert, authorized "maintenance electricians" who must strictly observe all the safety regulations concerning electrical systems.

Burns hazard

Burns hazard in the event of contact with hot surfaces. The electrical motors may be very hot.

All cleaning and maintenance operations must be performed by authorized expert personnel who must wear the necessary PPE and observe all safety procedures.

Dust inhalation hazard

Although the product is not harmful to humans, the operator should in any case use appropriate PPE to protect the respiratory tract. Possible inhalation and/or contact with airborne substances during the work cycle.

Insufficient mechanical strength hazard

There is an insufficient mechanical strength hazard if blades break.

The operator must use adequate PPE.

Tripping hazard

Danger of tripping over air lines connected to the control pedal or over the pedal itself.

The pneumatic air lines run through a sheath which can be walked on which should remain securely fastened to the floor.

The control pedal is installed in a yellow casing which is easily identified and fitted with a handle so that it can be moved manually to the desired operating position.

Solid material ejection hazard

Danger of solid materials being ejected by the rotating blades, e.g. shavings and swarf and blade teeth in the event of breakage.

Danger of high pressure fluid ejection

Danger of high-pressure fluid ejection inside the pneumatic system.

Before performing any operations on the pneumatic system the operator must make sure the power supply has been disconnected by pressing the cut-off valve.

The operator must use adequate PPE.

1.8. DESCRIPTION OF SAFETY FUNCTIONS

Protective devices installed on the machine

! DANGER - WARNING
IT IS STRICTLY PROHIBITED TO REMOVE THE SAFEGUARDS AND SAFETY DEVICES EXCEPT WHEN STRICTLY NECESSARY FOR THE PURPOSE OF CARRYING OUT MAINTENANCE WORK.

When such safeguards and safety devices need to be removed all necessary measures must be adopted to highlight this situation immediately and minimise any possible associated hazards.
The safeguards and safety devices must be refitted as soon as the reasons for their temporary removal are no longer applicable.

Machine guards and safety devices

Ref.	GUARDS / PROTECTIVE DEVICES - POSITION
A	Adjustable guard
B	Fixed guard
C	Moveable guard

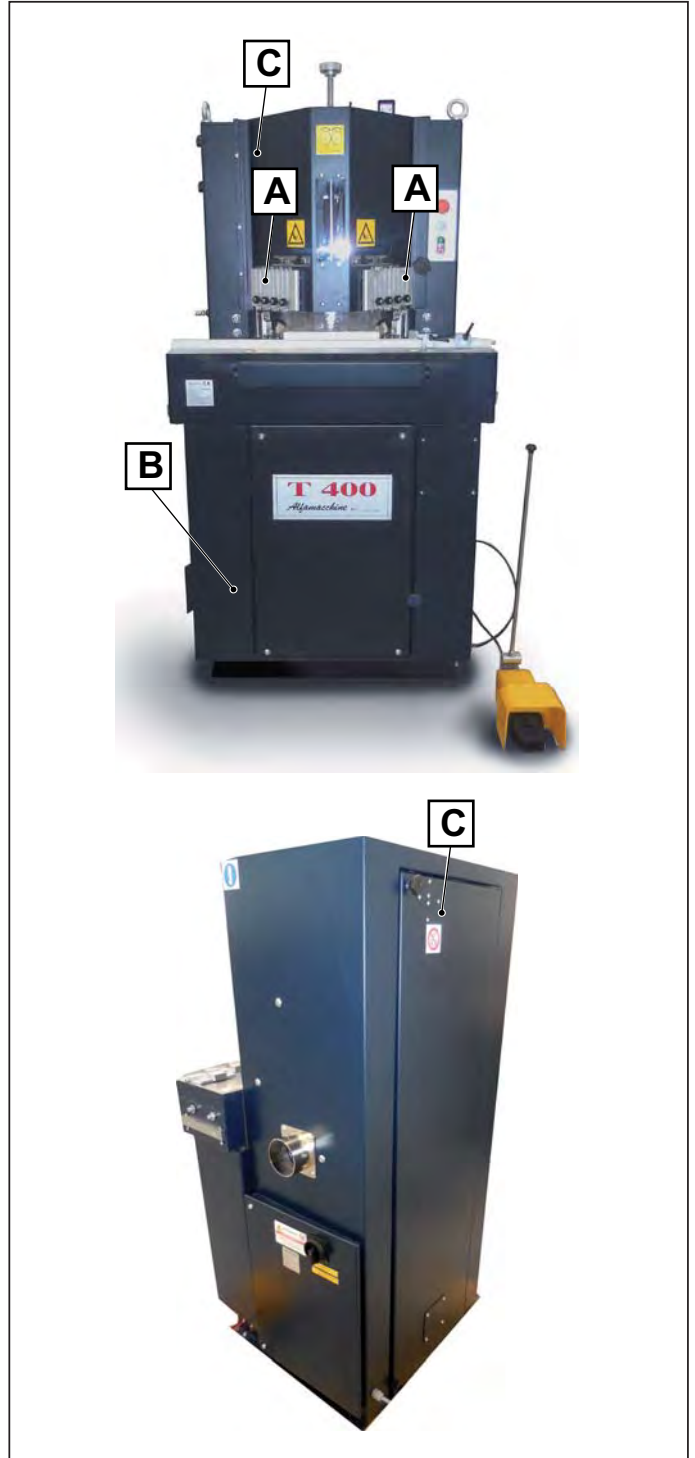

The machine is fitted with two safety switches:

1. Located on the blade access area front moveable guard.
2. Located on the rear moveable guard used to access the interior of the machine.

The safety switches are designed to immediately stop the machine if the operator opens a safety guard during the machine operating cycle.

The machine will only restart when the guards have been closed and the envisaged start operations performed.

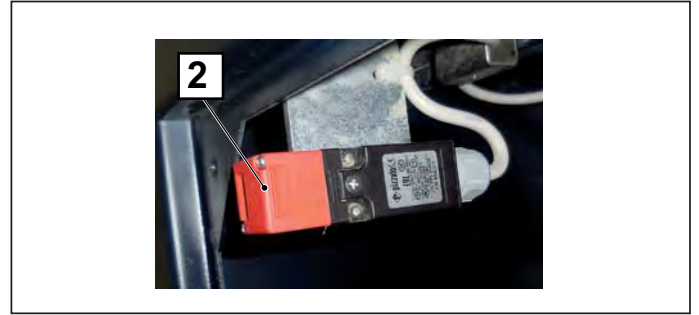
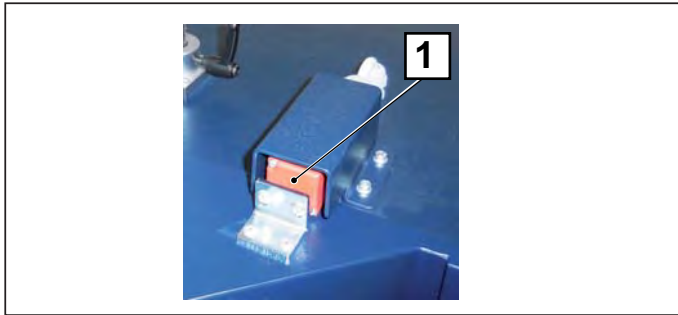

⚠ DANGER - WARNING
ACCESS TO AREAS PROTECTED BY A MOVABLE GUARD IS ALLOWED FOR BOTH THE MACHINE OPERATOR AND MAINTENANCE TECHNICIAN. IRRESPECTIVE OF THE CIRCUMSTANCES, THE MACHINE OPERATOR MUST NEVER ATTEMPT TO VOLUNTARILY CIRCUMVENT A FIXED GUARD.

- access to areas protected by a fixed or mobile guard is allowed only for maintenance technicians.
- Before starting the machine, all guards and safety devices must be correctly installed, adjusted/tuned and made functional, adhering meticulously and carefully to the indications provided in the installation, use and maintenance manuals accompanying said safety devices (all of which are supplied with the machine) and this instruction manual.
- The manufacturer strictly prohibits any tampering, even partial or momentary, with any of the safety devices present on the machine, because they are installed specifically to ensure the physical safety of operators and other persons present in the machine operating area.
- Violation of this regulation will give rise to risks and is in conflict with statutory legal regulations concerning safety in the workplace.

1.9. MACHINE DESCRIPTION

The operator, standing in front of the machine, manually loads the workpiece to be cut, activates the clamping system using the pedal control and activates cutting using a two-hand control. The machine executes the cutting stroke and, when at least one of the two-hand control buttons is released, the cutting unit returns to the high position (stand-by).

1.10. MAIN MACHINE COMPONENTS

In its configuration, the machine is made up of a series of operating units and zones, including:

- A. Working bench
- B. Vertical descent blade unit
- C. Vertical clamping devices
- D. Horizontal clamping devices (optional)
- E. Guards
- F. Two-hand control
- G. Pneumatic pedal control
- H. START/STOP button panel
- L. Emergency stop button

The individual parts which make up the machine are described below.

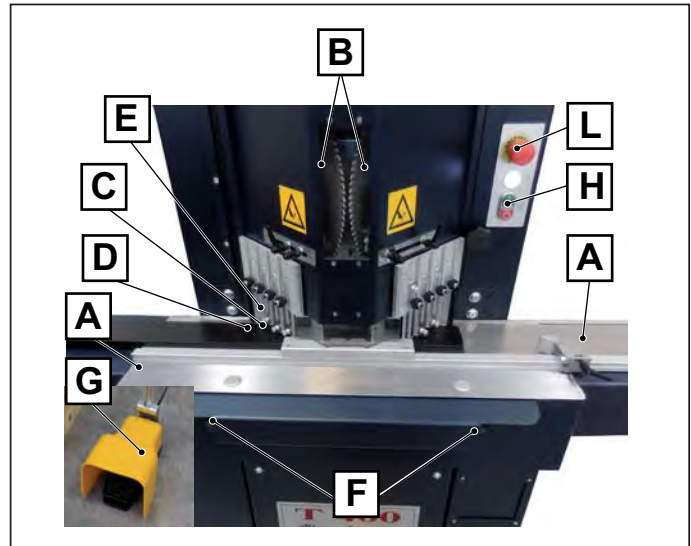

Working bench

The working bench is made up of a central section (1) and two side extensions (2).

The working bench is fitted with a guide (3) on both external sides of the blades on which two cutting stops are positioned, a fixed one (4) and a moveable one (5) which can be adjusted thanks to the graduated scale on the right arm of the machine.

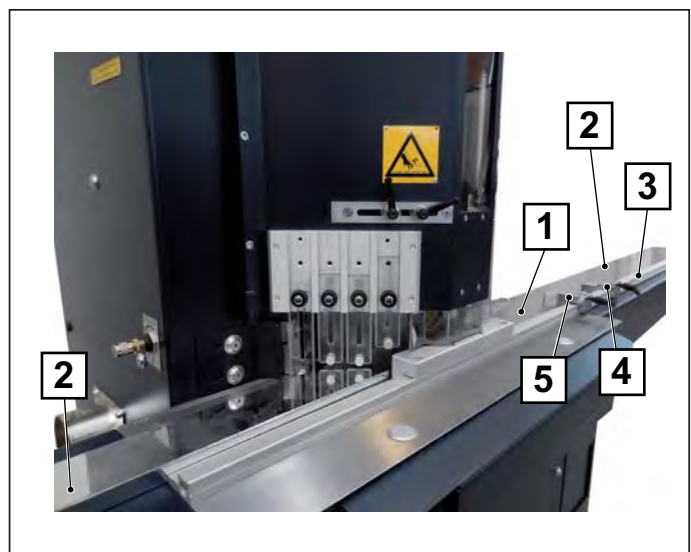

Vertical descent blade unit

The blades (6) are positioned at 45°. The right-hand blade turns counter-clockwise while the left-hand blade turns clockwise. The blade unit moves downwards in a vertical direction and then goes back up to the initial position when cutting has been completed.

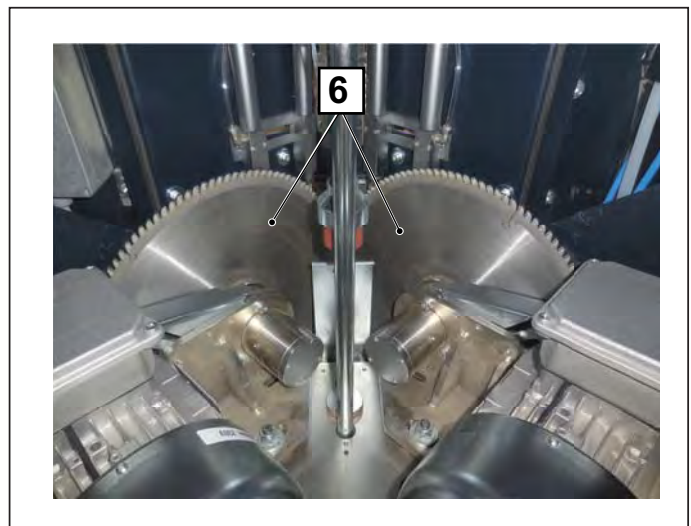

Clamping devices

The workpiece clamping system may be vertical (1) and/or horizontal (2) (optional version).

Vertical clamping (1) is brought about by two or four rubber stoppers, depending on the position of the relative selector:

- selector switch (3) controls activation of 1 or 2 stoppers:
- selector switch (4), controls horizontal clamping (accessory).

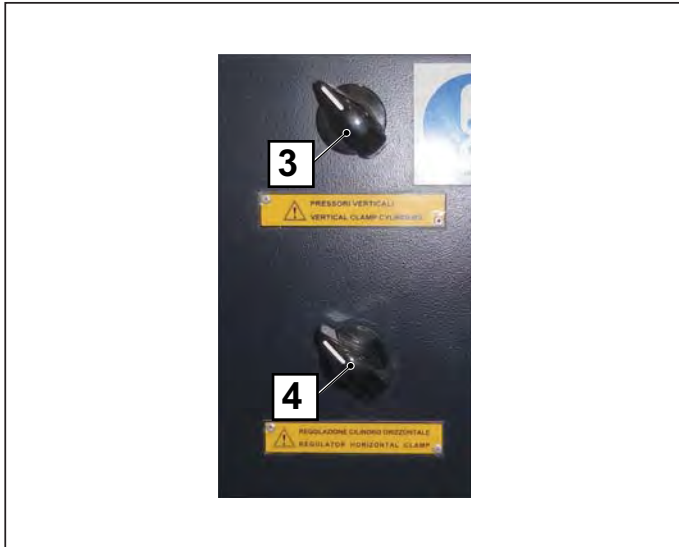
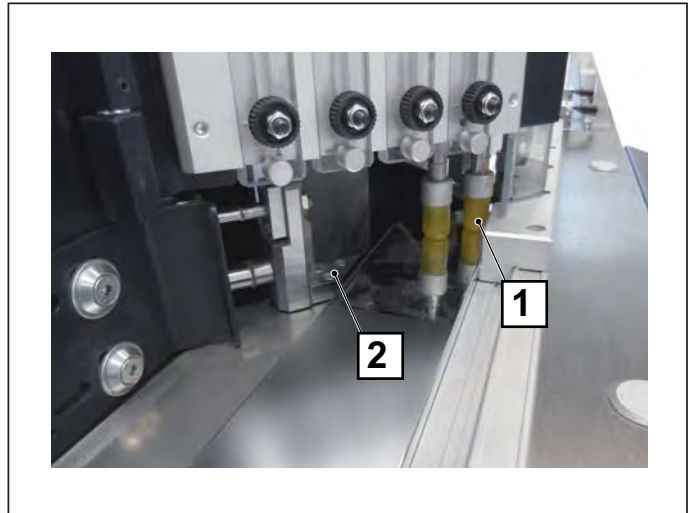

Both clamping systems are pneumatically operated.

- pressure regulator (5), located to the side, is used to adjust the vertical clamping pressure.
- pressure regulator (6), located to the side, is used to adjust the horizontal clamping pressure.

Both are activated by means of the pneumatic control pedal (7). The clamping pressure must be adjusted to suit the characteristics of the workpiece.

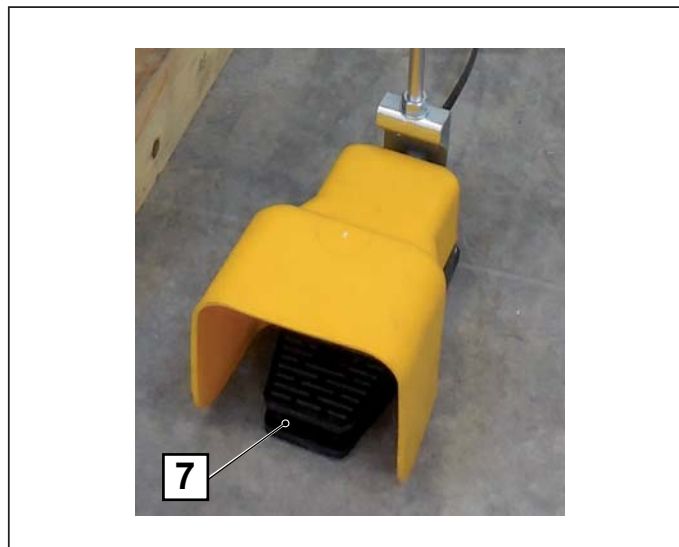

Guards

The machine is fitted with polycarbonate guards (1) which can be adjusted in height using the knobs (2). These guards must be adjusted based on the profile and the moulding to be cut and stop the operator from putting his hands into the machine.

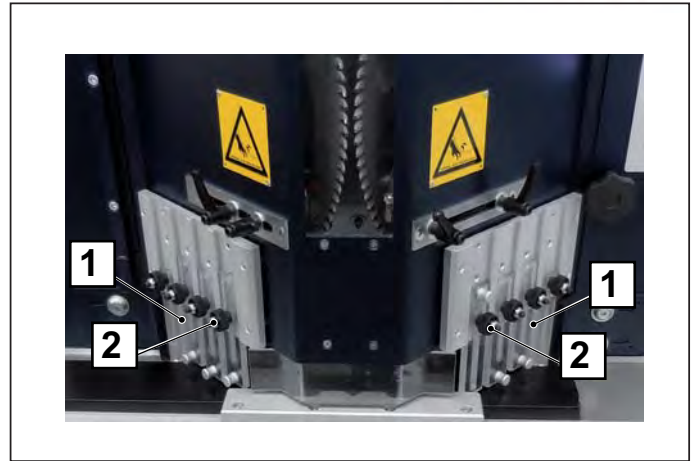

Two-hand control

The machine is fitted with a two-hand control (2). When pressed simultaneously the machine executes the cutting stroke and, when at least one of the control buttons is released, the cutting unit returns to the high position (stand-by).

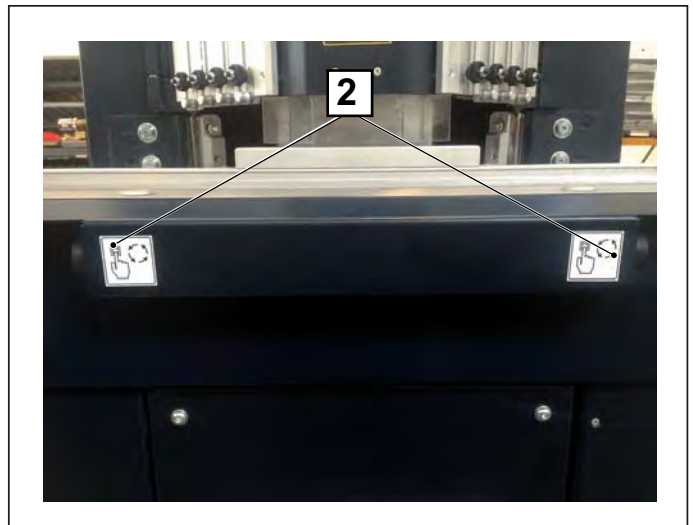

Pneumatic pedal control

The operator, standing in front of the machine, manually loads the moulding to be cut and secures it in place using the vertical and/or horizontal clamping system by pressing the pneumatic control pedal (3). Clamping is deactivated by releasing the pedal.

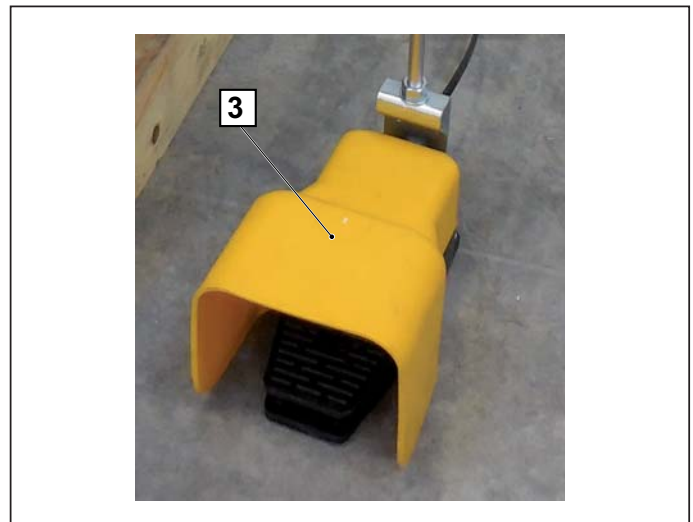

Start button

The machine is equipped with a control panel to one side. The buttons indicate:

1. START - the machine is ready to start (blades rotating)
2. STOP - the machine is stopped (blades stationary);
3. PILOT LIGHT - indicates the machine is powered
4. EMERGENCY STOP button.



Side extensions (optional)

Based on operating requirements, extensions can be fitted to both sides of the machine, Each extension is 1200 mm long and is fitted with support legs and adjustable feet.

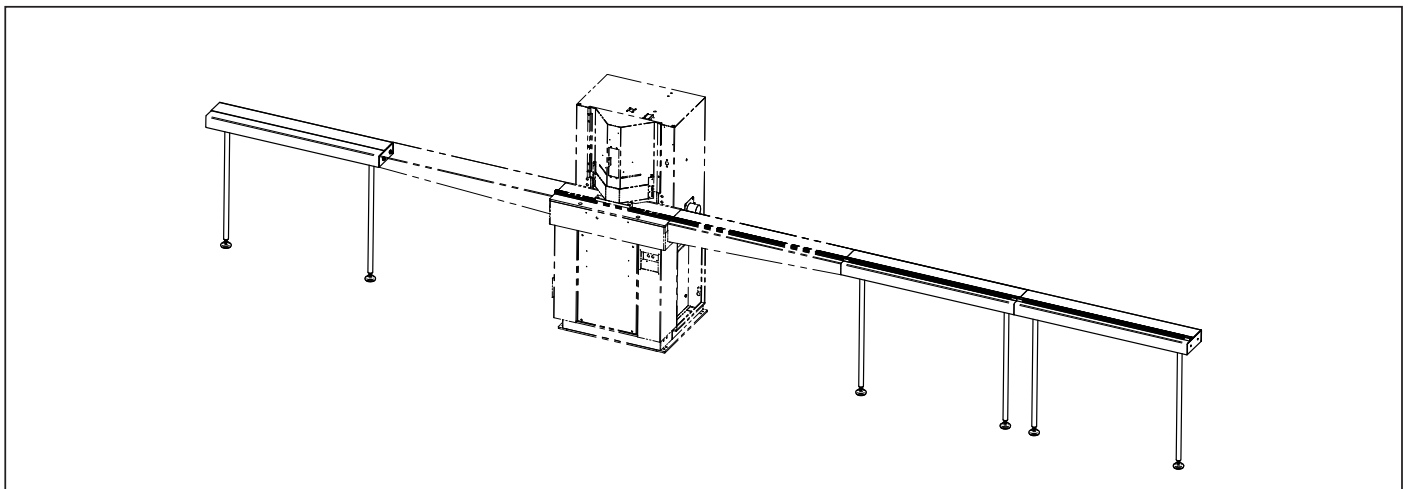

2. INSTALLATION

2.1. STORAGE

The machine, intended for indoor installation must be stored, if necessary, in well ventilated storage facilities and protected from dust. The delivered elements must remain in their original packing until the time of final installation. All parts of the machine subject to the risk of oxidation are protected with grease and protective sprays at the time of dispatch to prevent oxidation caused by weather conditions.

In the case of prolonged inactivity the machine must be stored with all necessary precautions taken based on the location and expected storage times:

1. Store the machine in an enclosed place.
2. Protect the machine from impact and stress.
3. Protect the machine from humidity and excessive temperature differences (refer to the table below).
4. Do not allow corrosive substances to come into contact with the machine.
5. Check that the pack has not been damaged and that it is perfectly dry.
6. Specifically, if the machine is inside a shipping container, the storage area must be covered and protected against direct weather including rain, snow and hail, and it must be accessible exclusively to authorized personnel.

The machine is protected in such a way as to withstand the temperatures, humidity and vibration levels typically associated with transport and storage.

Ambient temperature	-25 ÷ +40°C - 13 ÷ 104°F	Avoid places where there may be unexpected changes in temperature which could lead to the formation of condensate or freezing.
Storage temperature	-25 ÷ +55°C - 13 ÷ 131°F 0 ÷ +55 °C / 32 ÷ 131°F	
Relative humidity	100% at a temperature of +25°C / 77°F Lower than 50% at a temperature of +40°C / 104°F	
Vibrations	Lower than 90% at a temperature of +20°C / 68°F	
Atmospheric pressure	5.9 m/s ² (0.6G) or higher 900 mbar or more	

Storage temperature is construed as a short-term value, e.g. during transportation. Condensation or freezing normally occurs in sites subject to significant temperature excursions. Even if relative humidity in such conditions falls within the values shown in the table, locations subject to significant temperature changes should be avoided.

2.2. CHECKS ON RECEPTION



NOTES

It is essential to check the packs at the time of arrival and in the precise moment in which they are received. The check is performed in two stages for each pack received to avoid misunderstandings with the shipping agent.

Administrative check

1. Crate number and number of packs.
2. Weight and size
3. Correspondence of information on shipping document with the material effectively delivered (description, serial number, etc). The technical data given on the machine identification plate must correspond with the data given in the technical data supplied).
4. Check correspondence between shipping document data and the order.

Technical check

1. Condition and intactness of packaging.
2. Check that the packaging shows no signs of visible damage caused during transport and handling operations.

All the above checks must be performed by inspection in the presence of the shipping agent's delivery person. If any damage is noted or the supply is incomplete or incorrect, inform the manufacturer's sales department immediately.



NOTES

In relation to the above prescriptions, the manufacturer informs the user that in compliance with current international and national rulings, goods are always shipped at the risk and responsibility of the purchaser and, unless otherwise stated in writing at the time of the order confirmation, freight travels without insurance cover.

2.3. TRANSPORT, LIFTING AND HANDLING

Dimensions, weight and handling of individual machine parts

MACHINE BODY AND STAND

Machine height1700 mm/66.93 in
Machine width.....830 mm/32.68 in
Machine length3200 mm/125.98 in
Weight of the machine500kg - 1102.31lbs
Size of the packaging3200x8300x1860

2.4 LIFTING AD HANDLING



DANGER - WARNING

THESE OPERATIONS MUST BE CARRIED OUT BY QUALIFIED OPERATORS. COPERION SHALL DECLINE ALL LIABILITY IF OPERATIONS ARE PERFORMED: WITHOUT DUE OBSERVANCE OF THE SAFETY REGULATIONS; BY UNQUALIFIED PERSONNEL; WITHOUT FOLLOWING THE SPECIFICATIONS PROVIDED IN THIS MANUAL.



DANGER – CAUTION

During these operations, the operator must wear all the personal protective equipment (PPE) needed to provide adequate protection.



DANGER - WARNING

IT IS NECESSARY TO USE LIFTING GEAR WITH AN ADEQUATE LOAD BEARING CAPACITY FOR HANDLING THE WEIGHT IN QUESTION.



DANGER – CAUTION

Before the machine is fully off the ground, check that it is correctly balanced.

Check that the handling area is clear and free of all obstacles which could bring about hazardous situations. NEVER walk or stand under suspended loads. Always deposit the machine on a surface which can support its weight.



Lifting FROM BELOW

The operations to lift and handle the machine must be carried out using either a forklift truck or a pallet jack, making sure that the forks of the chosen equipment are inserted correctly under the packaging or machine structure. Make sure the load is evenly balanced.

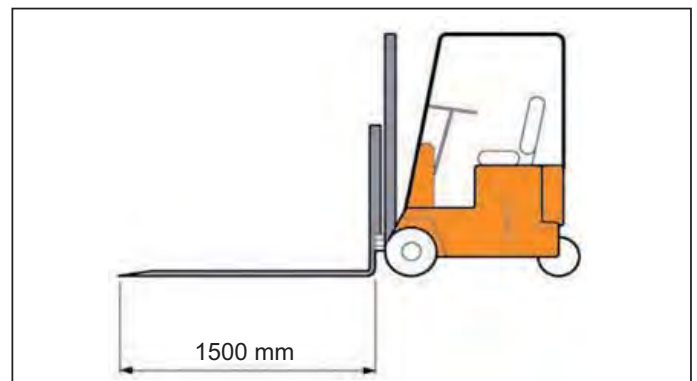

The forks on the equipment used to lift and handle the machine must be in good, undamaged condition and be at least 1500 mm 1/16 in. long.

When the machine is packaged on a pallet it must be moved by a forklift.

OVERALL WEIGHT: 550 KG / 1100LBS
DIMENSIONS: (1000X1000X1800)mm

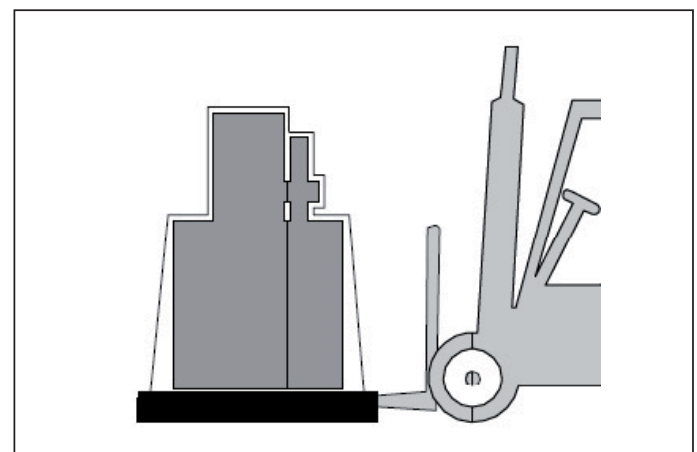

Handling with EYEBOLTS

The machine, freed from all packaging, must be lifted using suitable hoisting slings rigged up to the special eyebolts (1).

 **NOTES**
For information on the weight of the machine, please refer to the heading **TECHNICAL CHARACTERISTICS**

 **DANGER – CAUTION**

- During these operations, the operator must wear all the personal protective equipment (PPE) needed to provide adequate protection.

 **DANGER – CAUTION**

- Before the equipment is fully off the ground, check that it is correctly balanced.
- Check that the handling area is clear and free of all obstacles which could bring about hazardous situations.
- **NEVER** walk or stand under suspended loads. Always deposit the equipment on a surface which can support its weight.

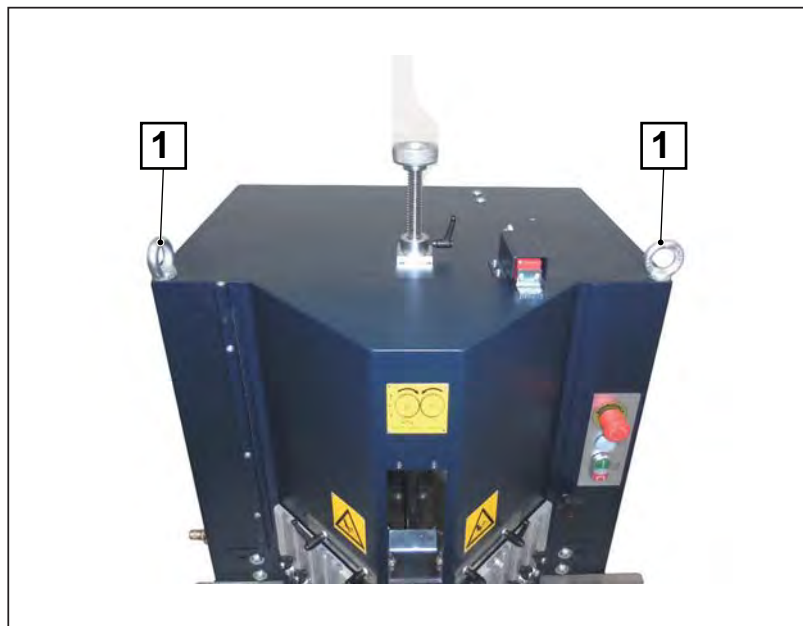

2.5. REMOVING THE PACKAGING

Description of the packaging

The machine may be shipped in a container or on a lorry. In both cases the same type of packing is envisaged which is suitable for guaranteeing the good condition and proper preservation of the machine during transport up to the time of delivery to the customer.

For correct balancing of the weight, pick up the machine using forklift equipment, inserting the forks in the points indicated by the arrows in the figure. Before proceeding to move the machine, make sure that the weight of the machine indicated on the packaging falls within the maximum hoisting capacity of the chosen lifting equipment.



DANGER – CAUTION

**Do not rig the machine up with belts for handling operations.
Do not stack machines on top of each other in storage.**

When storing the machine, never stack two machines packed on a pallet with shrink wrap.



NOTE –It is advisable to keep the packaging in case it is needed to store or transport the machine at a later date.

The various packing materials must be disposed of in compliance with the relative legislation in force. Seek advice from the delegated authorities and/or the assistance of specialist companies authorised to dispose of pollutant or recyclable waste products.



DANGER – CAUTION

Warning – pollution hazard: do not dispose of the packing material in the environment; retain it for future transport uses or consign it to a recycling company. Evaluation and management of the packing materials in terms of biological compatibility are the duty and responsibility of the user.

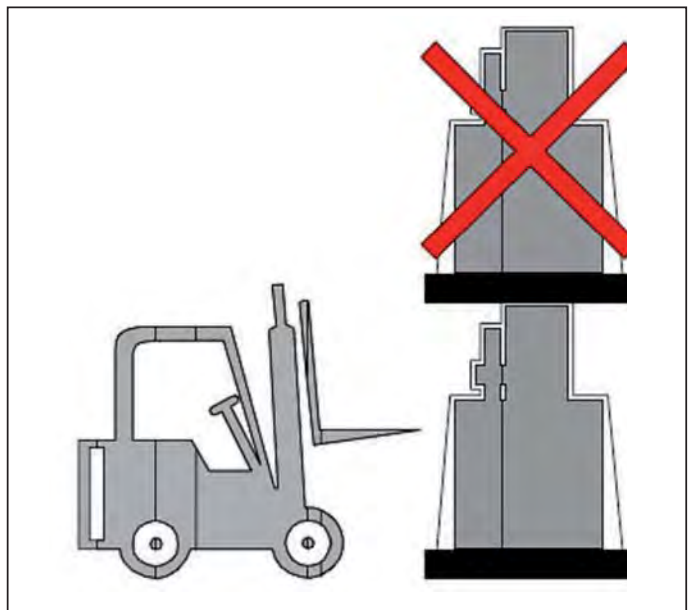
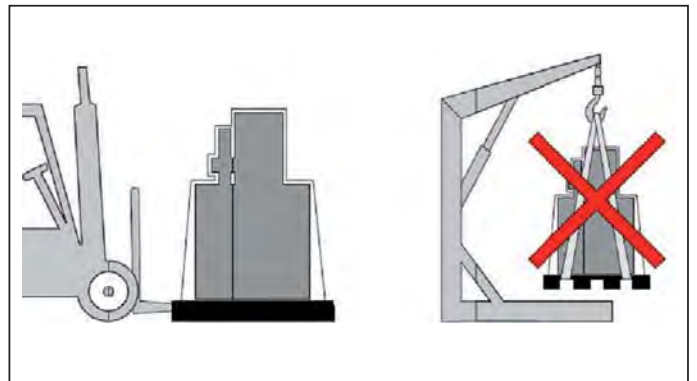
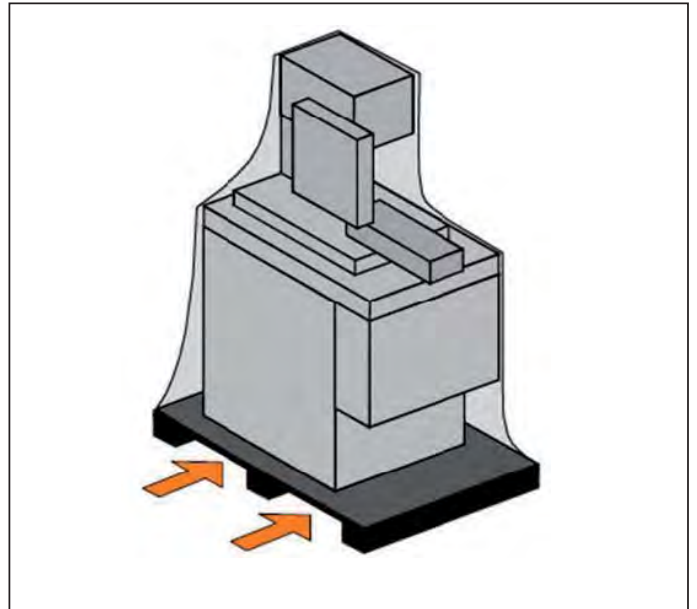

3. PRELIMINARY PREPARATION AND ADJUSTMENT PROCEDURES

3.1. POSITIONING

Suitability of the floor – supporting surface

The machine must be positioned on a solid foundation.

The foundations must have an adequate load bearing capacity to support the weight of the machine. The foundations must be designed and created by the employer.

Preparation on site

The machine layout is provided as an attachment to this manual. It is complete with the necessary data for positioning on the factory floor.

THE PLACE IN WHICH THE MACHINE IS USED must be clean and free of obstacles (see figure).

TO ALLOW FOR EASY REMOVAL OF THE MACHINE FOR MAINTENANCE it must be positioned in a place having the surface dimensions indicated in the figure.

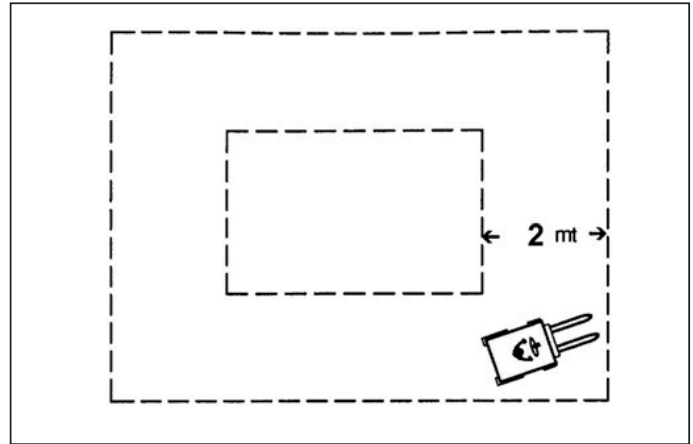

3.2. SECURING THE MACHINE TO THE FLOOR

Stability of the machine is designed in such a way that, in the specified conditions of operation, it can be used without risks of overturning, falling, or uncontrolled displacement.

In order to avoid mechanical stress during normal use of the machine and undue strain to the structure, during lifting operations the machine must be secured to the ground as described below:

- Drill holes in the floor to match up with the machine base;
- Secure the machine in place using Fischer M8x50 mm bolts;



NOTE – Once the machine has been secured to the floor, check that the working bench is perfectly level.

3.3. ASSEMBLY OF SEPARATELY SHIPPED UNITS

It is assumed, for the safe use of the assembly, that the reader of this paragraph is already familiar with the indications provided in paragraph "SAFETY INSTRUCTIONS".



DANGER – CAUTION

All assembly activities concerning machine units supplied separately, include highly delicate operations which call for significant experience. Consequently they must be carried out exclusively by personnel appointed directly by the manufacturer or authorised by the same and, in any case, under the manufacturer's responsibility. These activities are therefore the sole responsibility of the machine manufacture's personnel.

Installing the pressure gauges

The machine is built so that two pressure gauges can be installed which the operator must secure in their relative seats:

- pressure regulator (4), adjusts the vertical clamping pressure.
- pressure regulator (5) (optional), adjusts the horizontal clamping pressure.
- the filter and lubrication unit (6) adjusts the machine's operating pressure. It is fitted with a padlockable safety block which cuts off the compressed air supply and empties the system of air.

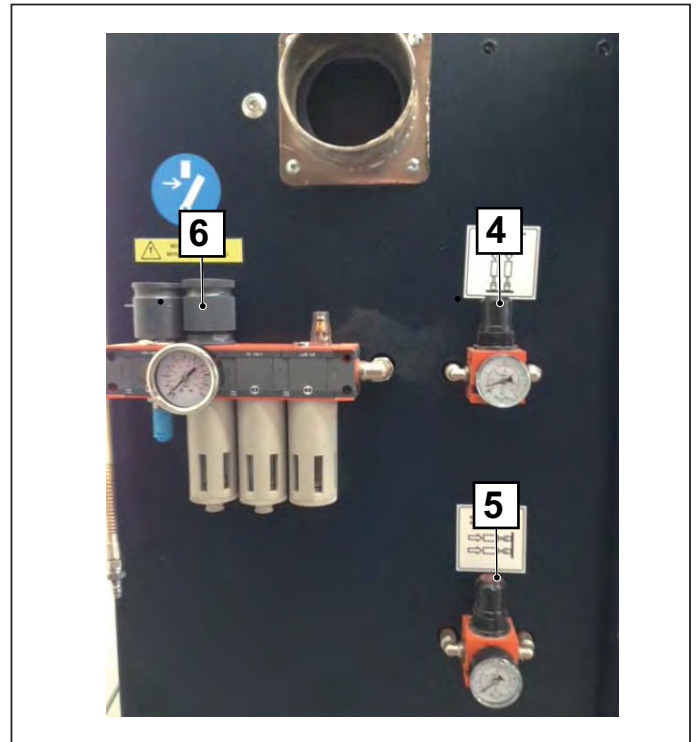

Pneumatic pedal hook-up

To activate the vertical and/or horizontal clamping devices, you must connect the pneumatic control pedal to the machine, consequently, connect the 2-way pneumatic control pedal (3) and the air lines to the connectors in the following order:

- connect the RED line to connector (1);
- connect the WHITE line to the external, operator-side connector (2);

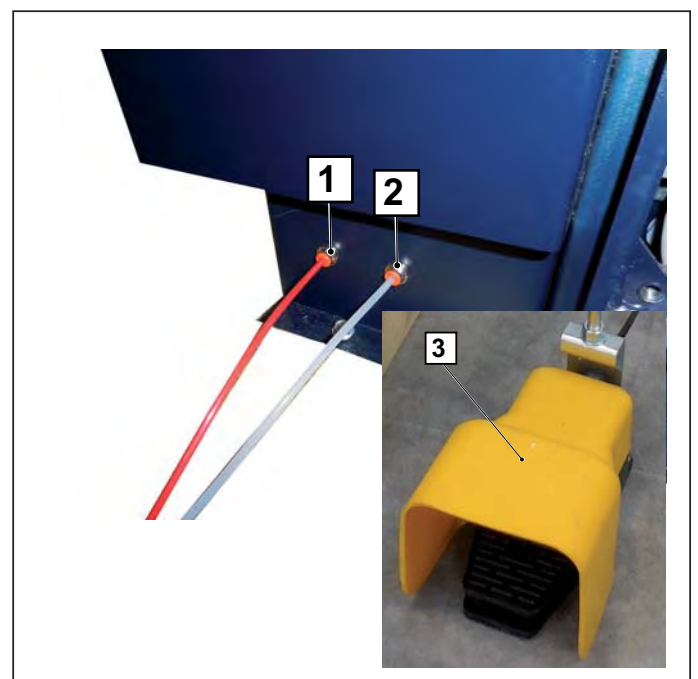

Extractor unit installation

The machine is fitted with two side extractor outlets (1), Ø80 mm or Ø100 mm (optional).

Connect up the extractor system to the two outlets using suitable pipes. If necessary it is also possible to use a third outlet by attaching it to the access hole located on the rear door.

The extractor system must have certain characteristics, please refer to heading 1.4 Technical Characteristics.



Installation of right and left extensions

After checking the correct alignment of the machine, proceed to install each extension as follows:

LEFT EXTENSION

- Position the extension;
- Slacken the screws (2);
- Using the grub screws (3) and the screws (4) correctly align the extension with the working bench.

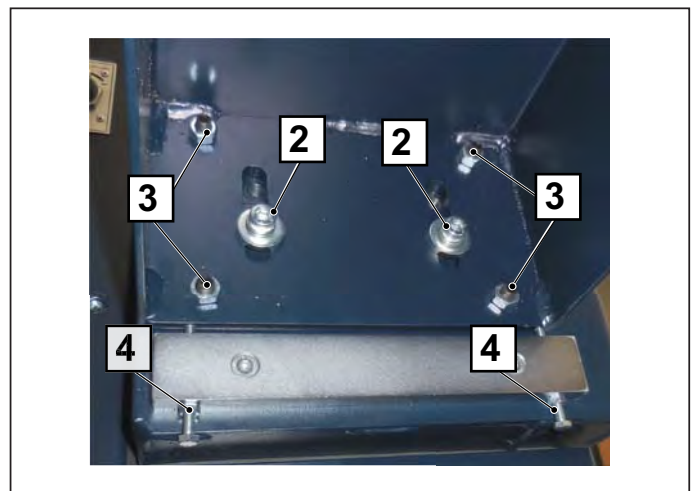

RIGHT EXTENSION

- Position the extension, inserting it on the pin (5);
- Slacken the screws (2);
- Using the grub screws (3) and the screws (4) correctly align the extension with the working bench.

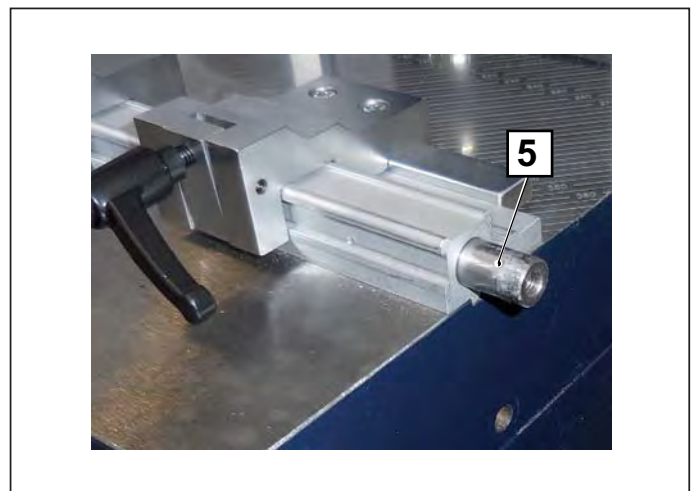

After completing installation of the parts supplied separately, proceed with electrical and pneumatic hook-up.

Pneumatic unit hook-up

Connect the compressed air line (1) directly to the inlet on the filter regulator and lubrication unit positioned on the left side of the machine. Use the quick-fit connector or other coupling which is suitable for the system.

The filter unit is fitted with an air inlet valve which is manually operated by a special button (2).

When the button (2) is not pressed, compressed air is not delivered to the machine and air from the pneumatic system and the internal auxiliary tanks is removed.

The button in the "not pressed" position can be padlocked for the execution of machine maintenance operations.

To power the machine, press the button (2).

When the button (2) is pressed, compressed air powers the internal circuits, however all pneumatic controls will be enabled only after pressing the blades START command.

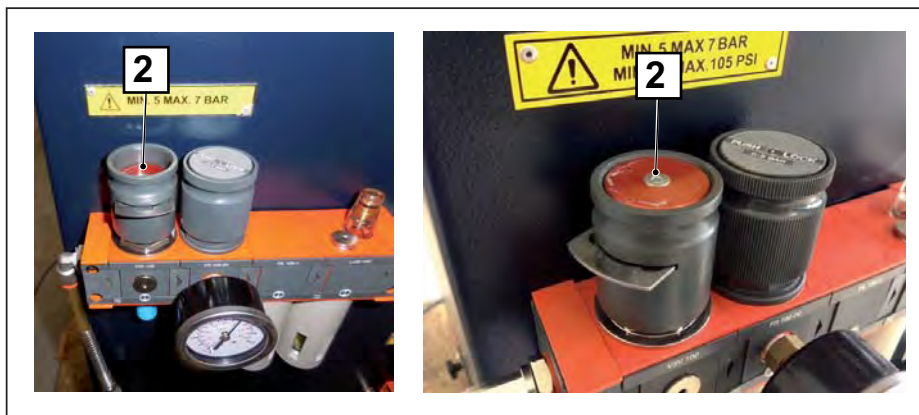

Electrical hook-up

Electrical hook-up of the machine must be done at the Customer's responsibility and expense. To perform electrical hook-up, connect the machine to the three-phase power supply provided by the customer.

The machine must be connected to the mains, taking into consideration:

- The laws and technical standards in force at the time and in the place of installation.
- Connect the Machine to the mains paying attention to the correct use of the earth cable.

The machine comes supplied with approximately 5 meters of electrical cable. The plug is not included and must be provided by the user. To provide effective protection against indirect electrical contacts, it is advisable to connect the machine to an industrial power socket fitted with a 16 A thermal-magnetic with 30 mA sensitivity differential tripping.

Furthermore, the interrupted short-circuit current, limited to the supply point, must be less than 10 kA.



NOTE –Once hook-up operations have been completed, check blade rotation at first start-up. If necessary, invert the phases (see the dataplate affixed to the machine).

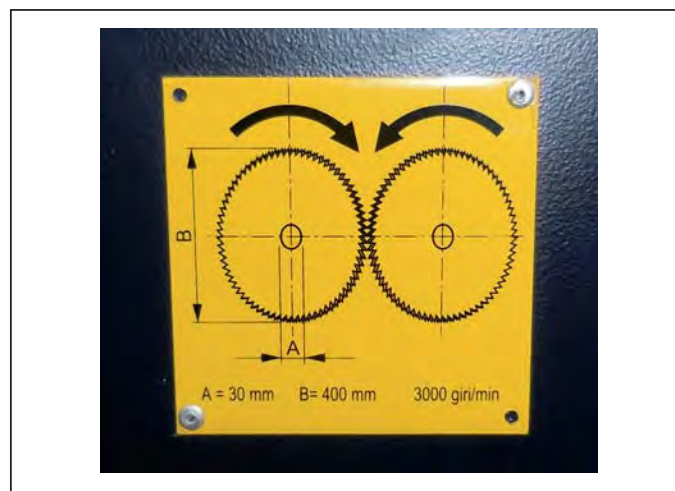

4. INITIAL START-UP AND USE OF THE MACHINE



DANGER - WARNING

THE MACHINE MUST ONLY BE OPERATED BY AUTHORISED AND DULY TRAINED PERSONNEL WITH ADEQUATE TECHNICAL EXPERIENCE.

MACHINE OPERATORS MUST BE AWARE OF THE FACT THAT KNOWLEDGE AND IMPLEMENTATION OF THE SAFETY RULES ARE AN INTEGRAL PART OF THEIR WORK.

UNQUALIFIED PERSONNEL MUST NOT BE ALLOWED ACCESS TO THE MACHINE'S OPERATING AREA WHILE IT IS IN USE.

Before switching on the machine, operators should:

- carefully read all the technical documentation
- know which protective equipment and emergency devices are available on the machine, where they are located, and how they work

The partial removal of safety guards and warning signs is forbidden.

Unauthorised use of commercial parts and accessories belonging to safety guards and safety devices can result in malfunctions and the occurrence of hazardous situations for operators.

Before starting the production cycle, the operator must be thoroughly familiar with:

- The position, function and use of all controls.
- The position, function and use of all safety devices.
- The machine's characteristics.
- This manual, and know how to consult it.

The operator must also have been appropriately trained.

4.1. WORKSTATIONS AND OPERATORS' TASKS

The machine described herein is designed to be run by 1 operator suitably trained and instructed with regard to residual risks. The operator must have the same skills, in terms of safety, as the maintenance technicians and adequate professional competence. The normal work area of the operator and relevant tasks/assignments are:

- The manual introduction/removal of mouldings onto the working bench, with the fixed safety guards closed and locked.
- Adjustment and tooling of the main machine units.
- General monitoring of machine operation - for example checking the cleanliness of the machine, etc. In the event of a problem, the operator must not intervene, but simply call the Maintenance Service.
- Cleaning of all the external and internal areas/parts of the machine which need cleaning.

The operator is responsible for the operating process, and must control the machine by means of the command actuators located on the control panels.

Apart from normal machine operation, the operator must also start and stop the machine in normal conditions, and stop it in emergency conditions.

The operator must also carry out checks and general monitoring operations while the machine is running. In the event of a problem he/she must not intervene, but simply call the Maintenance Service.

All operations performed by the operator must be carried out with all protection devices activated, all guards in place, and all safety devices engaged in order to prevent the risk of injury to arms, legs and other body parts.

All handling operations, preparation, adjustments, installation and connection of power supplies, along with fine-tuning and operating checks, must be carried out by trained, skilled maintenance personnel.

All maintenance and control operations must be carried out by trained and skilled maintenance personnel.

The main hazardous work areas of the machine, that may produce risks for the operator, are:

- the workpiece stoppers activation zone;
- The area inside the machine during adjustment, tooling and cleaning operations.

4.2. CHECKS, ADJUSTMENTS AND START-UP

All functions/operations pertaining to operating modes must always comply with safety measures and the prescriptions for the protection against residual risks.

During normal production, the machine must only be used to process the products specified herein.

During the working cycle, it is essential to comply with safety measures and prescriptions for the protection against residual risks.

4.3. START-UP

Before proceeding with first machine start-up, you must carry out the checks indicated below:

- Check that all guards are correctly installed;
- Check that the moveable guards are correctly closed;

Once these checks have been completed, proceed with machine start-up as follows:

- Activate the dust extractor system (1);
- Activate the compressed air supply by pressing the cut-off valve (2) control;
- Check that the front pilot light (4) is on (i.e. that the machine is powered);
- Press START (3).

The machine is ready to start work.

! DANGER – CAUTION
Before proceeding with cutting operations, you must execute the necessary adjustment procedure to correctly perform the production process.



Blade descent speed adjustment

Depending on the material being handled, it is necessary to adjust the blade descent speed by acting on the rotary switch (1). Adjustment is made by means of visual observation by the operator.

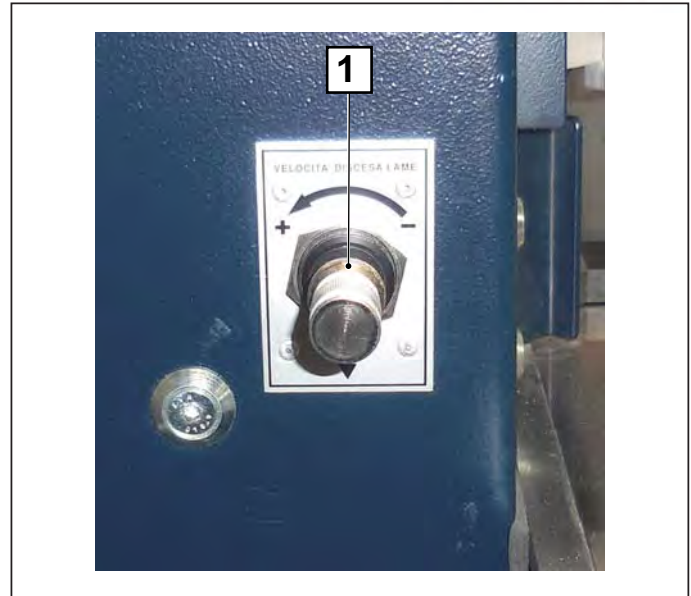

Selecting the type of clamping

Depending on the type of moulding you wish to cut, enable the most suitable clamping.

By means of the relative switch (2) it is possible to activate:

- Single vertical clamping, by turning the switch left;
- Double vertical clamping by turning the switch right.

If the machine is also fitted with horizontal clamping (optional), this can be enabled or disabled as required.

Therefore, based on requirements, act on switch (3);

- command enabled by turning the switch right;
- command disabled by turning the switch left.



Clamping pressure adjustment

Again, based on the material being handled, it is necessary to adjust the clamping pressure.

Using the pressure regulator (1), adjust the vertical clamping pressure.

Using the pressure regulator (2), adjust the horizontal clamping pressure.

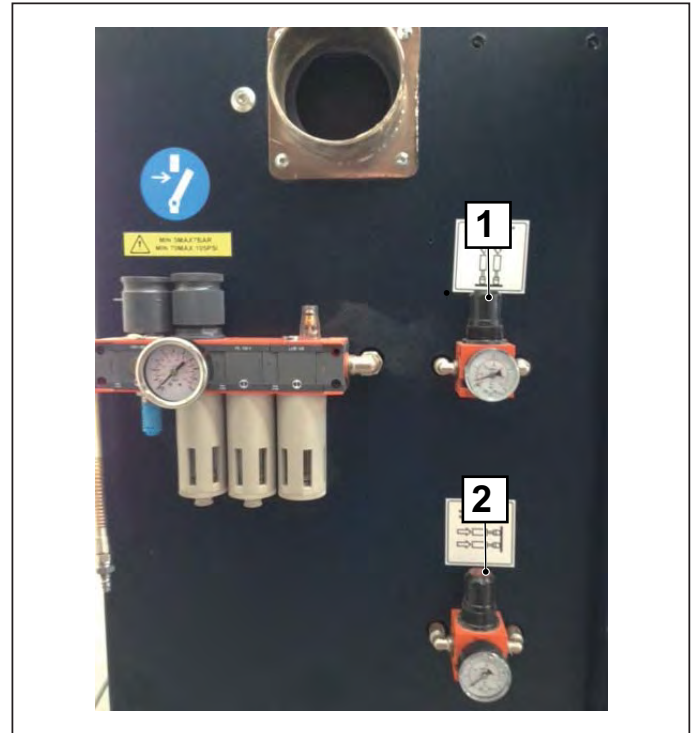

Upper blade unit stop position adjustment

To make this adjustment proceed as follows:

- Slacken the handle (3),
- Act on the knob (4);
- Tighten the handle (3).

This adjustment must be made by visually observing the descent needed for optimum cutting.

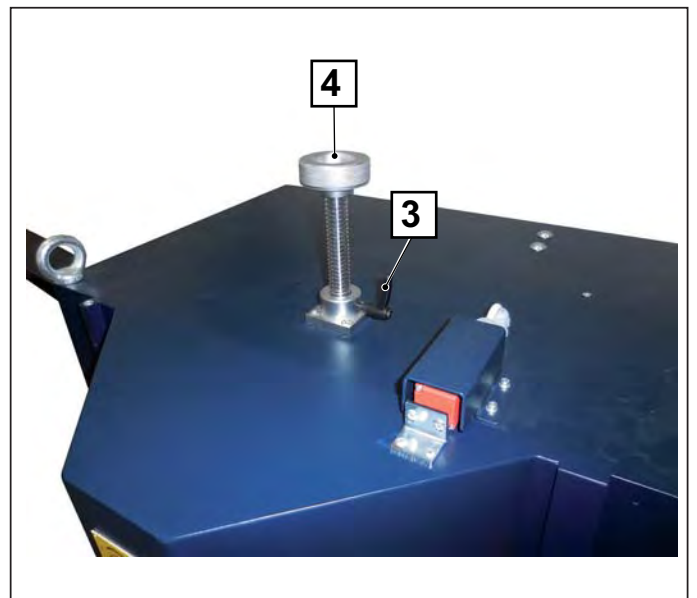

Guard adjustments

Once the moulding has been placed in the operating area, it is necessary to adjust the safety guards, adapting them to the size of the moulding, making sure, however, that they do not interfere with the cutting procedure.

To adjust, simply slacken the knob (1), lower the individual guards (2) and retighten the knob.

Repeat this operation for all the guards installed on the machine.

! **DANGER – CAUTION**
NEVER attempt to use the machine unless all the guards and other safety devices needed to operate the machine safely are in good working order.



Vertical stopper position adjustment

To achieve optimum clamping of the workpiece, adjust the position of the stoppers by acting on the four handles (3), therefore:

- slacken the handles (3);
- position the stoppers (4) based on the moulding to be cut;
- tighten the handles.

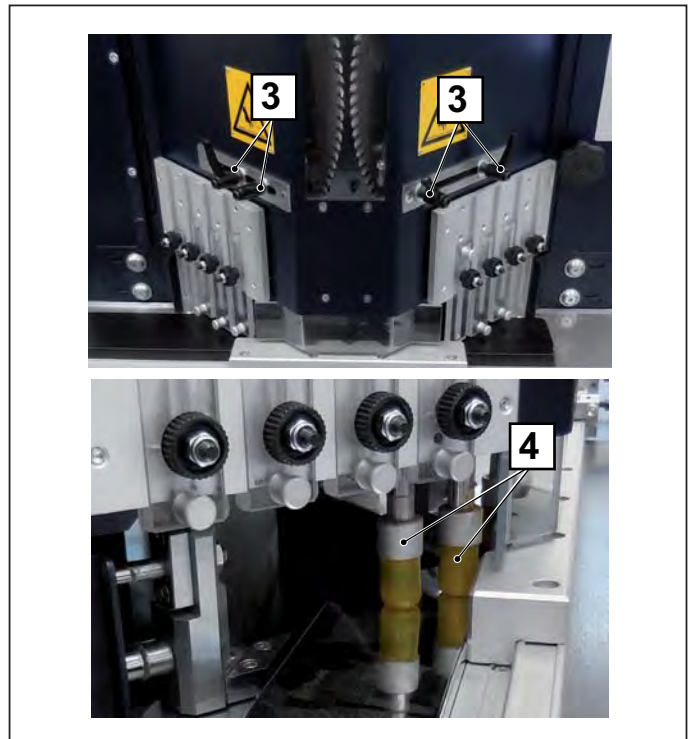

Horizontal stopper adjustment (optional)

Based on the size of the moulding you wish to cut, it may be necessary to remove or install the horizontal contrast stopper (6). To install or remove the stopper (6) simply act on the screws (5).

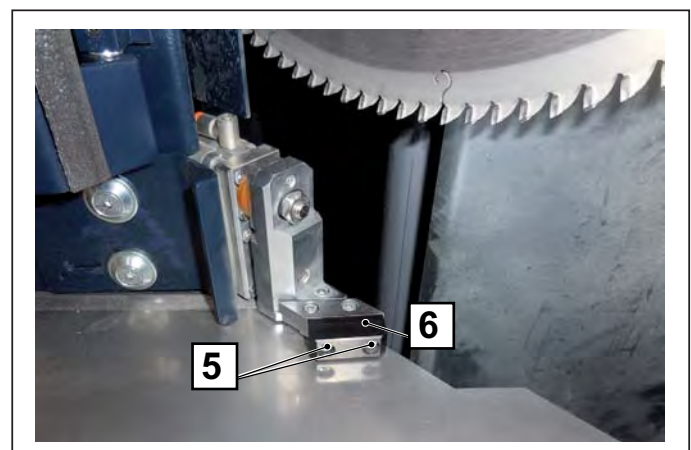

Cutting length stops

The machine has two stops which slide along the entire length of the aluminium guide.

These are used to determine the two cutting lengths which, when making rectangular frames, correspond to the two long and the two short sides.

There are two different kinds of stop:

Mobile stop (A):

this is the one located closest to the blades and establishes the length of the shorter frame side.

Fixed stop (B):

This cannot be lifted out of the way like the mobile stop and is used to establish the length of the longer frame side.

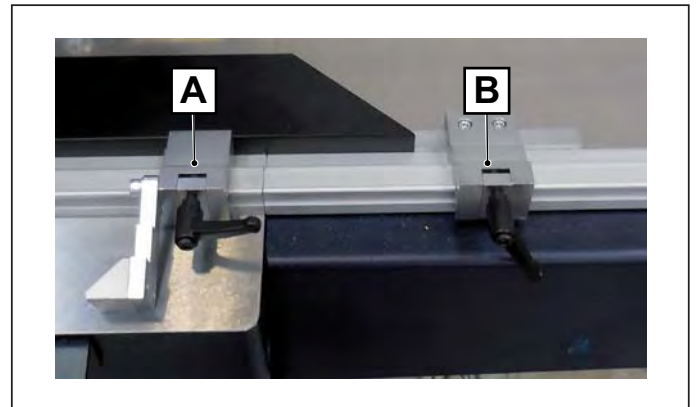

The correct combination of the two stop lengths makes it possible to switch quickly and easily from one length to the other by simply lifting the mobile stopper out of the way.

By adding and setting additional mobile stops it is possible to set other cutting lengths.

Measuring the cutting length

The moulding support surface, starting from the cutting bench top and along the entire length of the extension to the right of the blades, has a graduated scale (1), the 45° markings on which make it possible to size the INTERNAL (2) length of the frame to be cut, regardless of its width.

Using the internal edge of the moulding cut at 45° for reference, set the cutting length measurement by matching this internal edge with the relative etched line indicating the required distance from the blade.

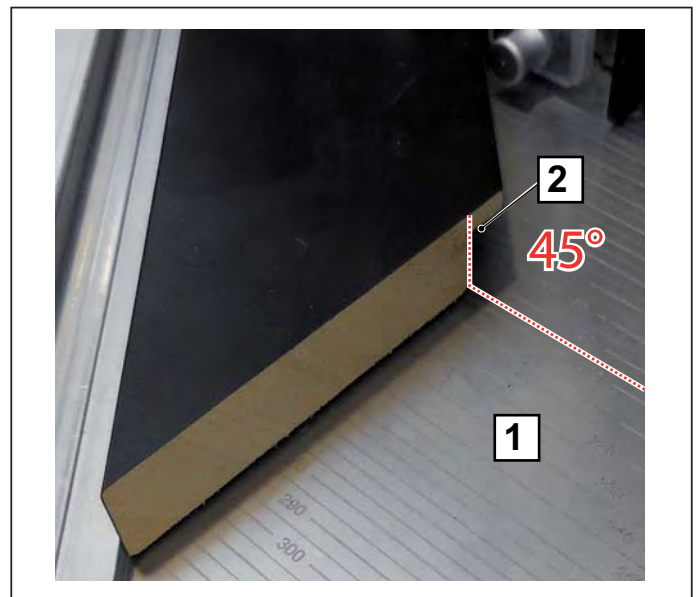

Once you have set the correct measurement, slacken the handle on the stop (3) and run it along the guide until it comes up against the workpiece and then retighten the handle.

Repeat this procedure for the other measurements and stops you wish to position.

NOTE – Being as it is not possible to determine the exact measurement between the middle line on the graduated scale, it is advisable to carry out a test cut to check the end measurement and correct if necessary.

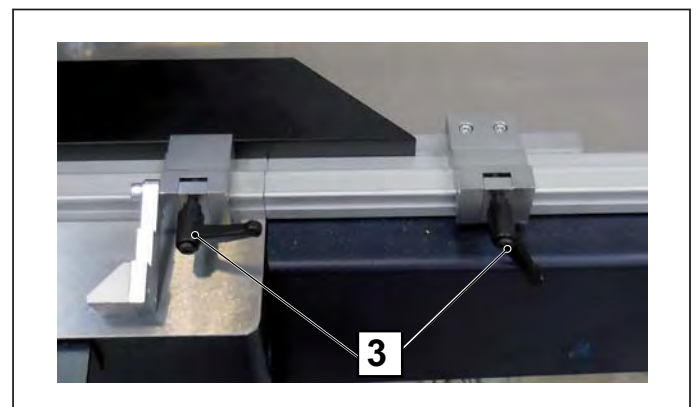

External measurement of the workpiece

The graduated scale gives an indication as to the internal measurement of the cut workpiece, but should you wish to know the external measurement, as in the case of cutting mouldings for CANVAS, you must calculate the external dimension on which to set the stops by means of this simple formula:

$$Mi = Me - (2 \times La)$$

Legend

Mi = Internal Measurement
Me = External Measurement
La = Moulding width

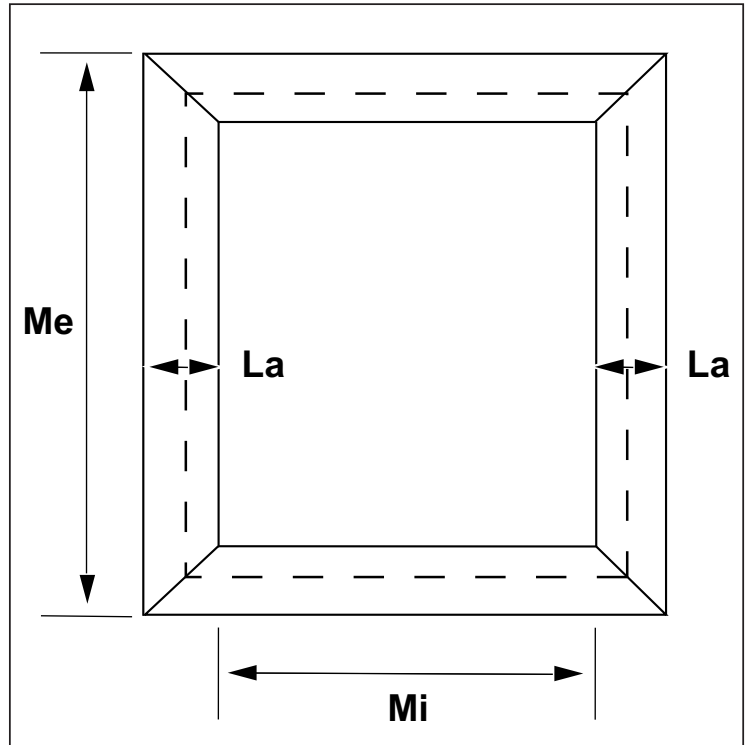

4.5. WORKING CYCLE



DANGER – CAUTION

During normal use, the machine must only process the products/materials indicated in this manual.

Safety measures and the indications on residual risks must always be observed during machine operation.



NOTE - For all the installation and adjustment procedures, please refer to the relative chapters in this manual.

- Check the type of material you wish to cut;
- Check the blade type installed on the machine;
- Check and adjust the cutting unit descent speed, based on the material being handled, using the rotary selector and visual observation;
- Check and adjust the pressure of the clamping devices;
- Act on the clamping selectors to activate or deactivate the clamping devices you wish to use;
- Position the moulding to be cut on the working bench;
- Adjust the guards;
- Adjust the position of the stoppers to obtain optimum stability for the next stage using the pedal. Make sure the moulding is correctly positioned;



NOTE – For optimum cutting, check the quality of the moulding material then:

- avoid any materials with visible twists;
- make sure the extensions are level.

- Carry out a test cut using the two-hand control buttons. Check the mouldings for any signs of burns. If there are any, increase the blade descent speed (see Troubleshooting);
- Set the cutting length by adjusting the position of the two stops;
- Insert the moulding;
- Block the clamping devices by pressing the pedal;

The machine is now ready to start cutting.

4.5.1. CYCLE STOP



DANGER - WARNING

THE MACHINE IS EQUIPPED WITH EMERGENCY STOP BUTTONS (1) THAT THE OPERATOR MUST USE EXCLUSIVELY IN THE PRESENCE OF HAZARDOUS SITUATIONS THAT CALL FOR IMMEDIATE STOPPING OF THE MACHINE. WHEN AN EMERGENCY STOP BUTTON IS PRESSED THE MACHINE STOPS.

TO RESTORE OPERATION FIRST RESTORE THE CONDITIONS FOR SAFE OPERATION OF THE MACHINE AND THEN RELEASE THE EMERGENCY STOP BUTTON BY TWISTING THE HEAD.

When one of the two control buttons is released the blades are lifted but continue to rotate.

To stop the machine, press the STOP button (2).



5. MAINTENANCE, TROUBLESHOOTING, AND CLEANING

DANGER – CAUTION

It is assumed, for the safe use of the machine, that the reader of this chapter is already familiar with the indications provided in CHAPTER 1.7 “SAFETY INSTRUCTIONS”. Pay particular attention to the residual risks linked to maintenance operations.

5.1. MAINTENANCE TECHNICIAN REQUIREMENTS

The term "maintenance" does not just cover periodical controls of normal machine operation, but also the analysis and consequent rectification of any of those problems which for any reason stop the machine from working properly or not at all.

Specifically, personnel appointed to perform the servicing, cleaning, replacing of parts and troubleshooting, must work in compliance with the following aims:

1. limit the deterioration of wear parts.
2. reduce accidents to the absolute minimum.
3. reduce costs arising from faults.
4. limit the number and duration of interventions.
5. work in collaboration with the line operators to improve the efficiency of the plant.

DANGER - WARNING

THESE MAINTENANCE OPERATIONS MUST BE CARRIED OUT BY QUALIFIED OPERATORS. COPERION SHALL DECLINE ALL LIABILITY IF OPERATIONS ARE PERFORMED: WITHOUT DUE OBSERVANCE OF THE SAFETY REGULATIONS; BY UNQUALIFIED PERSONNEL; WITHOUT FOLLOWING THE SPECIFICATIONS PROVIDED IN THIS MANUAL.

5.2. WORK STATIONS AND MAINTENANCE TECHNICIAN DUTIES

The maintenance technician duties are:

- to perform tooling operations and adjust mobile parts on the machine,
- to calibrate, adjust and clean internal machine parts,
- to clean the inside of the machine (disassembling parts if necessary), carry out maintenance, lubrication, assistance operations, troubleshooting and the replacements of worn or damaged parts or structural elements.

The work zones that may present risks for the machine's maintenance technician are the following:

- the area relative to tooling, calibration, adjustment, lubrication, troubleshooting, worn and broken part replacement operations, as indicated in this instruction manual,
- the areas in and around the machine during the movement of mobile parts,
- the areas around piping;
- the areas around the fixed guards.

5.3. MAINTENANCE PRESCRIPTIONS

DANGER - WARNING

ALL THE MAINTENANCE, CLEANING AND PARTS REPLACEMENT MUST BE CARRIED OUT SOLELY AND EXCLUSIVELY WITH THE MACHINE DISCONNECTED FROM ALL POWER SUPPLIES.

It is prohibited to perform any maintenance work on parts that are in motion.

5.4. GENERAL WARNINGS

DANGER - WARNING

BEFORE PERFORMING ANY MAINTENANCE, CLEANING, REPLACEMENT OF PARTS AND TROUBLESHOOTING, PAY THE UTMOST ATTENTION TO THE DECALS AFFIXED TO THE MACHINE. DURING ALL ACTIVITIES DO NOT TAMPER WITH OR DEACTIVATE ANY OF THE SAFETY DEVICES FOR ANY REASON, EITHER TO CREATE BYPASSES OR TO USE THEM FOR PURPOSES OTHER THAN THEIR INTENDED USE AS PRESCRIBED BY THE MANUFACTURER.

After performing any of the above tasks on the machine, reset and reactivate all the safety devices.

Do not tamper with or deliberately damage the protective screens nor remove or conceal the warning notices. In the event of deterioration or illegibility of the safety decals immediately order replacements from the equipment supplier.

DANGER - WARNING

BEFORE PROCEEDING WITH MAINTENANCE, CLEANING AND/OR THE REPLACEMENT OF PARTS, ALWAYS PUT UP A SIGN WHICH IS CLEARLY VISIBLE INDICATING THAT MAINTENANCE OPERATIONS ARE UNDERWAY AND THAT THE MACHINE CAN ONLY BE RESTARTED AFTER HAVING DULY ASCERTAINED THAT ALL OPERATIONS HAVE BEEN COMPLETED AND ALL SAFETY GUARDS HAVE BEEN REPLACED.

DANGER – CAUTION

During these maintenance operations, the operator must wear all the personal protective equipment (PPE) needed to provide adequate protection.

5.5. ISOLATION FROM EXTERNAL ENERGY SOURCES

During maintenance, cleaning and replacement of parts, the machine must not be used and no commands must be transmitted. Before performing any maintenance, lubrication, cleaning and replacement of parts etc. external energy supplies must be disconnected:

- the power supply by turning the main switch (1) to OFF;
- the pneumatic system (2) by pressing the cut-off valve control.



NOTE - All disconnecting devices must be padlocked in the "0" (OFF) position.



5.6. ROUTINE MAINTENANCE

Personnel responsible for carrying out the operations described in this chapter must have read, understood and consequently observe all the safety prescriptions.

Furthermore, all general rules must be observed to keep the machine in perfect working order:

1. keep the machine clean and tidy,
2. avoid all damage,
3. avoid a situation wherein make-shift or urgent repairs become commonplace,
4. do not perform work on the machine which produces swarf; for example, should it be necessary to drill holes, carefully check that no residues end up in machine parts,
5. to dispose of any used or replaced materials, always adhere to the regulations in place in the country of use. Apply the principles of differentiated waste disposal.

5.6.1. TASKS THAT CAN BE PERFORMED BY THE OPERATOR

A list of all the periodical checks/inspections, adjustment and control operations and ROUTINE MAINTENANCE operations which can be carried out by the machine operator is provided below.

The position of the machine components is shown in the layouts provided as an appendix to this manual.

FREQUENCY	CHECK	METHODS AND RESULTS
Before each shift	Working area: <ul style="list-style-type: none"> • must be clean and free from dust 	The work station and all the parts outside the machine must be cleaned and all dust and objects must be removed which could impede correct operation and/or compromise the machine's original safety conditions. Remove all shavings from the machine with a jet of compressed air and lint-free cloths. For any type of intervention or to replace parts, call in the maintenance service.
Before each shift	Check operation: <ul style="list-style-type: none"> • of the emergency stop device; • of the command/control devices relative to safety; 	At the first sign of problems it is necessary to remedy the situation by implementing an inspection procedure to check the correct mechanical operation of the devices. For any type of intervention or to replace parts, call in the maintenance service. Parts must always be replaced using original spare parts or at least parts which provide equivalent quality and safety .
Before each shift	Visual inspection of the condition: <ul style="list-style-type: none"> • of fixed guards 	All fixed guards must perform the function they were designed for. Check their integrity, both internally and externally and make sure there are no signs of wear or breakage. For any type of intervention or to replace parts, call in the maintenance service.
At least once a week	Check operation: <ul style="list-style-type: none"> • safety switches 	Before starting the machine, check the condition of the safety guards and make sure the safety devices work correctly.
At least once a week	Visual inspection of the condition: <ul style="list-style-type: none"> • of all dataplates 	If they become unreadable new ones must be requested from the manufacturer or they must be replaced by the user with others carrying the exact same information.



NOTE – Only use low pressure pneumatic blow guns with safety cut-off nozzle.

Parts must always be replaced using original spare parts or at least parts which provide equivalent quality and safety .
 The instructions concerning the replacement are not given in this manual and they must therefore be explicitly requested from the machine manufacturer, which reserves the responsibility for the replacement interventions.

5.6.2. TASKS THAT CAN BE PERFORMED ONLY BY MAINTENANCE TECHNICIANS

The ROUTINE MAINTENANCE operations which must be performed by a maintenance technician are indicated below.

FREQUENCY	CHECK	METHODS AND RESULTS
When necessary	Check and, if necessary, replace: <ul style="list-style-type: none"> blades 	<ul style="list-style-type: none"> Check that all blades are intact. They must be replaced if there are any dents.
When necessary	Adjustment: <ul style="list-style-type: none"> of the cutting angle at 45° 	<ul style="list-style-type: none"> Increase or decrease the cutting angle.
When necessary	Positioning: <ul style="list-style-type: none"> of the blades 	<ul style="list-style-type: none"> Position the blades based on cutting requirements.
When necessary	Adjustment: <ul style="list-style-type: none"> of the vertical angle of the blades 	<ul style="list-style-type: none"> Adjust the verticality of the blades based on cutting requirements.
Every 6 months	Check, adjust tension and replace: <ul style="list-style-type: none"> of the belts 	<ul style="list-style-type: none"> Check the tension and condition of the belt. Replace with a new belt if necessary.
Each month	Visual inspection of the condition: <ul style="list-style-type: none"> of the vertical stoppers 	<ul style="list-style-type: none"> Check that the vertical stoppers are in good condition. Replace if necessary.
Every 6 months	Visual inspection of the condition: <ul style="list-style-type: none"> horizontal stopper (optional) wear 	<ul style="list-style-type: none"> Check the condition of the horizontal stopper. Replace if necessary.
Every year	Visual inspection of the condition: <ul style="list-style-type: none"> of the internal stopper (optional) 	<ul style="list-style-type: none"> Check the condition of the internal stopper. Replace if necessary.
Each month	Check and, if necessary, replace: <ul style="list-style-type: none"> the central Teflon support 	<ul style="list-style-type: none"> Check the condition of the central Teflon support. There must be no dents. Replace if worn or broken.
Every 6 months	Check: <ul style="list-style-type: none"> oil quantity in the pneumatic unit 	<ul style="list-style-type: none"> Check the level of the oil in the pneumatic unit. Top up if necessary.
When necessary	Adjustment: <ul style="list-style-type: none"> of the lubricator 	<ul style="list-style-type: none"> If necessary, adjust using a screwdriver.
Every 18 years	Replacement: <ul style="list-style-type: none"> Start button 	<ul style="list-style-type: none"> Check that the start button is intact. Replace if necessary.
Every 20 years	Replacement: <ul style="list-style-type: none"> Safety-related parts of control systems 	<ul style="list-style-type: none"> Check the condition of the control systems. Replace if necessary.

Blade replacement

(When necessary)

! DANGER – WARNING:
THE OPERATOR RUNS THE RISK OF CUTTING INJURIES DURING EXECUTION OF THESE OPERATIONS.

Proceed as indicated below:

- Open the front guard by unscrewing the relative knob (1);
- Using a suitable blocking tool (2), undo the screws (3);
- Remove the external flange (4);
- Remove the blade (5);
- Remove the internal flange (6);
- Clean the area.
- Check that all flanges are intact. There must be no dents or deformations.
- Install new blades and all the other individual parts.
- Execute blade balancing.

NOTE – The blades used must:

- be compliant with standard **EN 847-1** and designed to reduce noise emissions;
- only be those with a maximum permitted speed which exceeds the rotation speed of the blade-holder shaft;
- correctly sharpened.

NOTE – DO NOT use one-piece blades made from high-speed steel (HS).

Carrying out the above steps in reverse order. During reassembly it is important to:

- Correctly reposition the flanges;
- Correctly reposition the blade with the teeth pointing in the right direction for cutting.

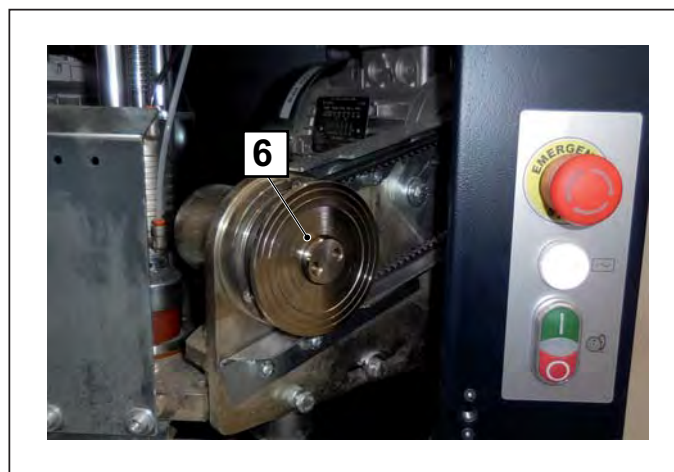
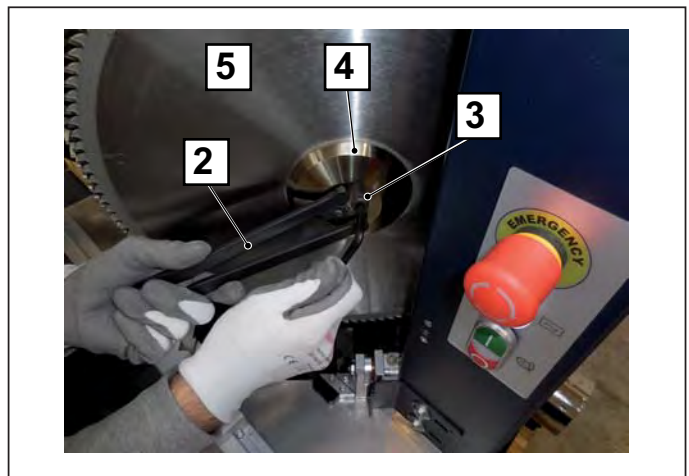
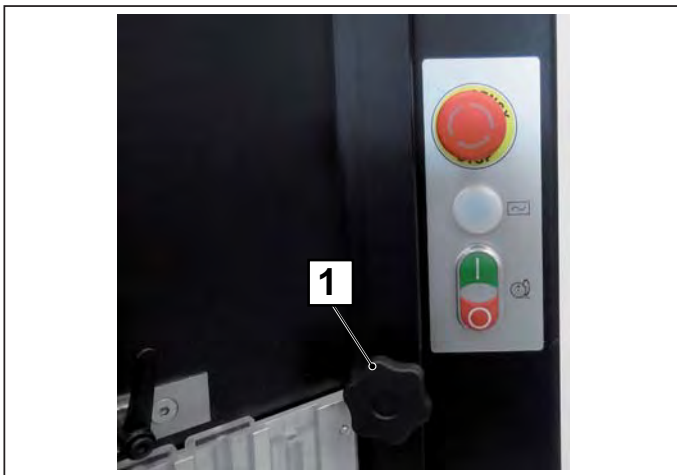

Cutting angle adjustment

(When necessary)

To increase the cutting angle, proceed as follows:

1. Check that screw C1 is tight.
2. Slacken nuts A1, A2, A3
3. Slacken nut E2
4. Slightly slacken screw C1
5. Slacken screw D2 by a quarter turn (max.) or as much as is necessary.
6. Tighten nut E2
7. Tighten screw C1
8. Using an indicator, check that the blade has reached the required angle and tighten nuts A1, A2 and A3.

To reduce the cutting angle, proceed as follows:

1. Slacken nuts A1, A2, A3
2. Slacken nut E2
3. Slightly slacken screw C1
4. Tighten screw D2 by a quarter of a turn (max.) or as much as is necessary.
5. Activate so as to block the nut E2
6. Tighten screw C1

Using an indicator, check that the blade has reached the required angle and tighten nuts A1, A2 and A3.

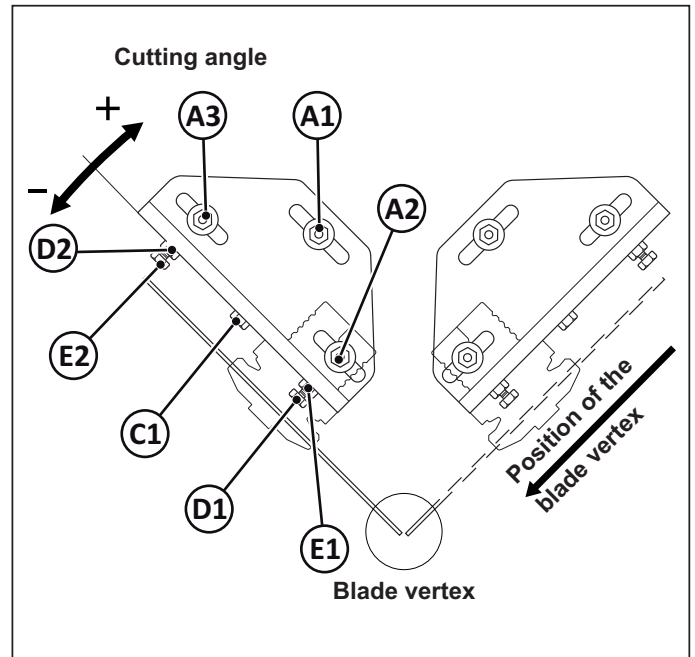

Blade positioning

(When necessary)

1. Slacken nuts A1, A2, A3
2. Slacken screw C1
3. Move the blade support forward so that the distance at the vertex between the two blades is 1.5 - 2.0 mm.
4. Tighten screw C1 and nuts A1, A2, A3.

Checking the vertical angle of the blades

(When necessary)

To adjust the vertical angle of the blades, proceed as follows:

1. Slacken nut A1
2. To increase the angle ("+" see drawing) slightly screw nut B1 (max. 1/8 of a turn)

To decrease the angle ("- see drawing) slightly unscrew the nut B1 (max. 1/8 of a turn)

3. Tighten nut A1
 4. check the vertical angle (using the relative dial indicator).
- Repeat the operations from step 1 to step 3 until the required position has been achieved.

 **NOTE** – Adjustment of the cutting angle, as described in points 1 and 2, can be carried out making full use of the adjustment slots in the supports.

 **NOTE** – Do not adjust the cutting angle by acting on the right-hand blade: it is advisable to act always and only on the left-hand blade.

 **NOTE** – For correct use of the blades, please follow the instructions provided by the blade manufacturer.

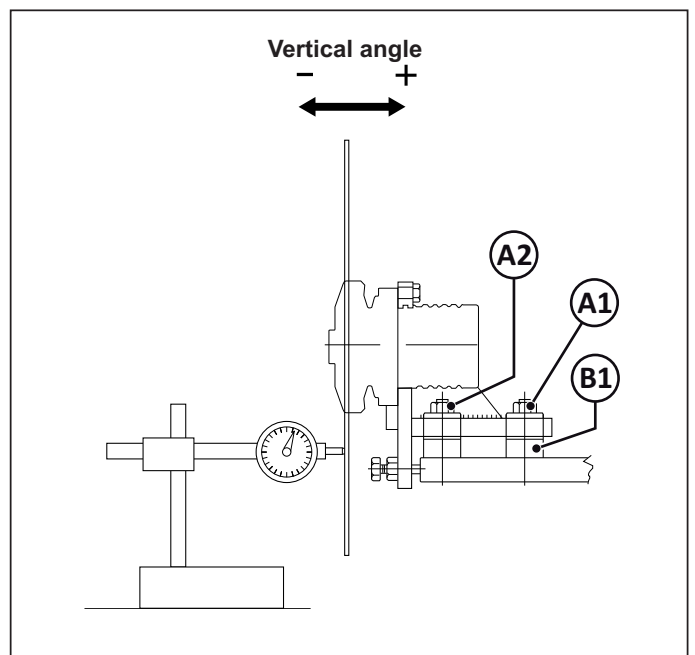

Checking, adjusting the tension and replacing the belt.

(Every 6 months)

! DANGER – WARNING:
DURING THESE OPERATIONS, THE OPERATOR
MUST WEAR ALL THE PERSONAL PROTECTIVE
EQUIPMENT (PPE) NEEDED TO PROVIDE ADEQUATE
PROTECTION.

To check the state of wear and the tension of the belt, proceed as follows:

Proceed as indicated below:

- Open the front guard by unscrewing the relative knob (1);
- Using a suitable blocking tool (2), undo the screws (3);
- Remove the external flange (4);
- Remove the blade (5);
- Remove the internal flange (6);
- Clean the area.

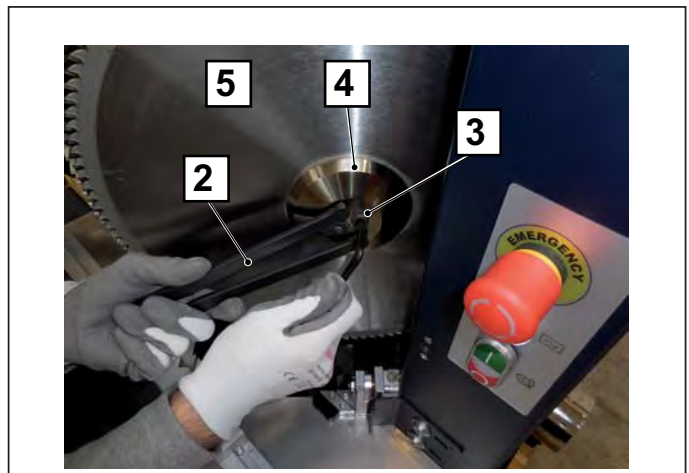
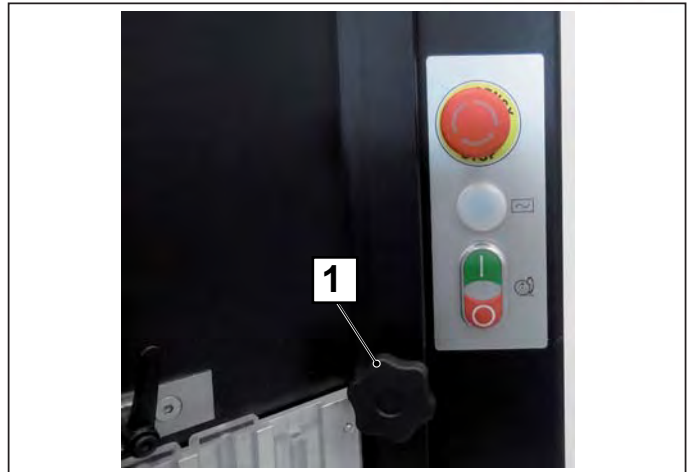

Check the state of wear and correct tension of the belt, if necessary:

- Slacken the two screws (7);
- Remove the guard (8);
- Slacken the screws (9);
- Tension the belt (10). Replace with a new belt if necessary.
- Tighten the screws (9) and repeat the steps in reverse order to reassemble.
- Close all the machine's safety guards and start the motors. Leave to rotate for about 10 minutes before proceeding to check the belt tension;

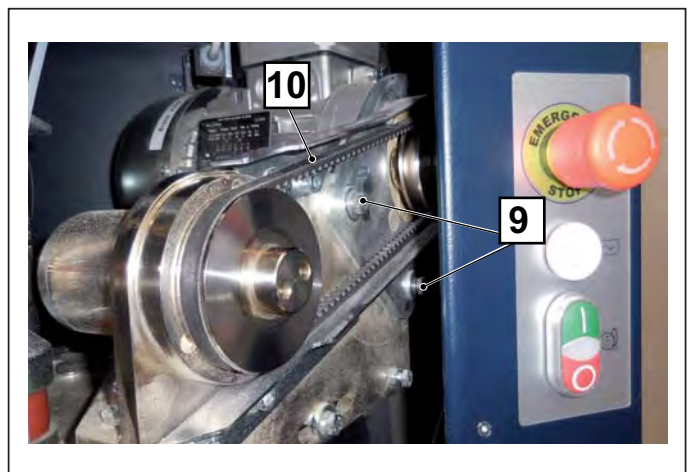
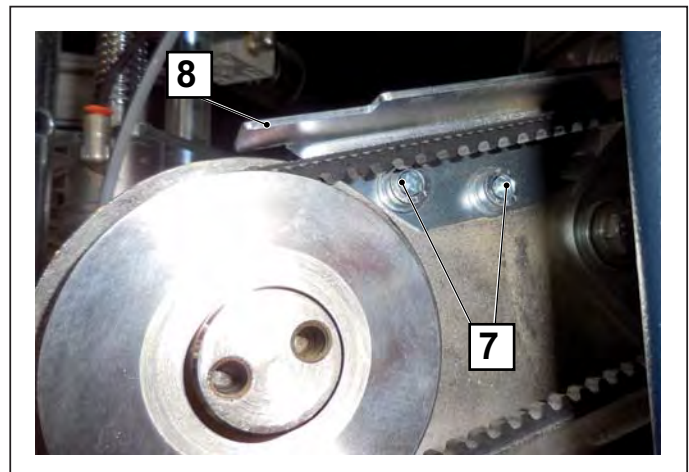

To check the tension of the belt, proceed as follows:

- On the upper mid-point of the belt, apply a downward thrust (F) towards the lower part of the belt of 5 kg.
- Measure the deviation (f) of the upper part, i.e. the camber caused by the thrust applied, which must be between 3 - 4 mm.
- Act on the aforementioned tensioning system to achieve different camber values.

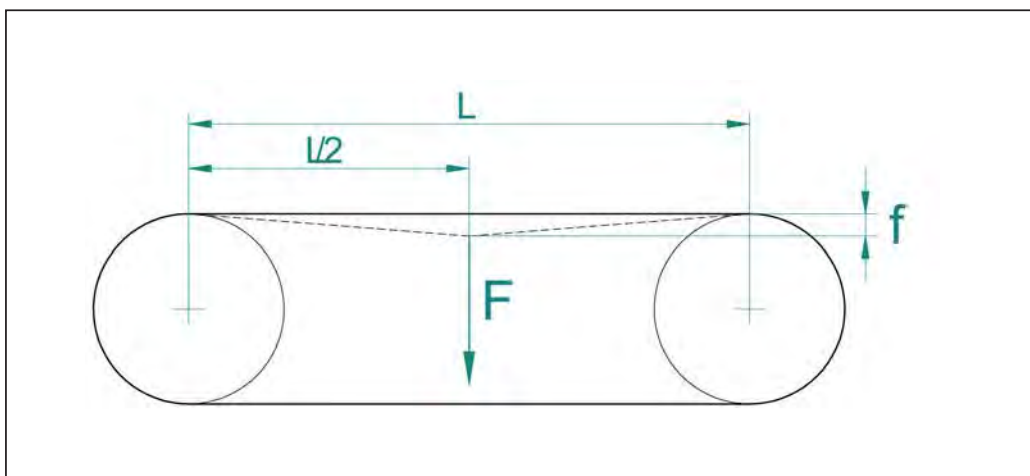

Carrying out the above steps in reverse order. During reassembly it is important to:

- Check that all flanges are intact. There must be no dents.
- Install new blades and all the other individual parts.
- Correctly reposition the flanges;
- Correctly reposition the blade with the teeth pointing in the right direction for cutting.

Condensate drainage from tanks

(monthly)

Although the filter regulator unit is fitted with anti-condensation trays, water may still form in the machine which deposits in the upper and lower tanks.

For correct operation of the machine and to ensure a longer service life for the pneumatic components, it is a good idea to periodically check the system and eliminate any traces of water.

- cut off the pneumatic power supply by pressing the air inlet button (1) on the filter unit;
- open the door on the back of the machine;
- identify the two internal tanks on the left side:
upper tank = line pressure (2);
lower tank = blade balancing circuit pressure (3);
- unscrew the cock located below each tank to remove any air left in the system (residual energy) and drain out any condensate or other liquids accumulated in the tanks;
- tightly close the condensate drain valve (4).
- close the door and supply air to the machine by pressing the relative button on the filter unit (1).

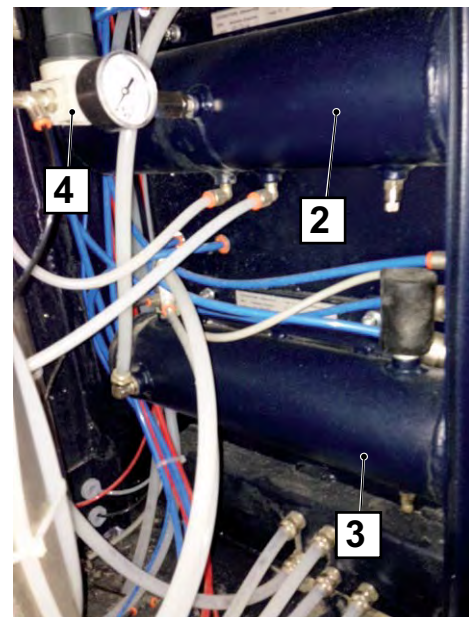

Check the vertical stoppers for wear

(monthly)

Check the condition of each individual stopper (1). If necessary, replace by slackening the grub screw (2) to remove and replace the aforementioned stopper (1).

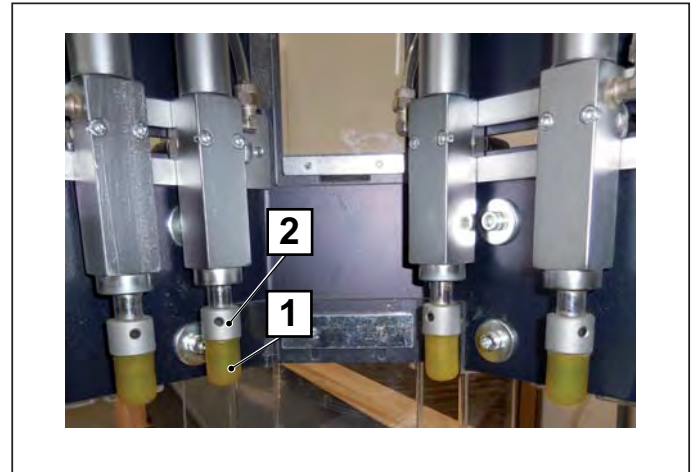

Checking the horizontal stopper (optional) for wear

(Every 6 months)

Check the condition of each individual stopper (3). If necessary, replace by slackening the screws (4) to remove and replace the aforementioned stopper (3).

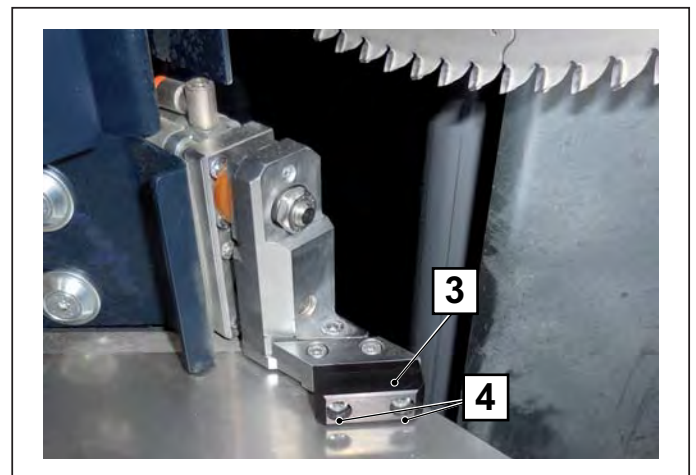

Checking the internal stopper (optional) for wear

(Every year)

Check the condition of the stopper (5). If necessary, replace by slackening the screws (6) to remove and replace the aforementioned stopper (5).

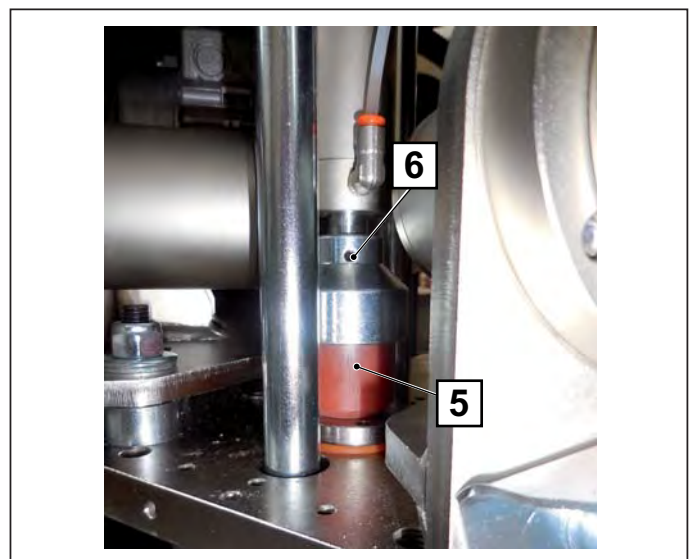

Replacing the central Teflon support

(monthly)

To replace the central Teflon support, proceed as follows:

- Carry out the procedure to remove the blades as described in the relative heading "Blade Replacement".
- Slacken the screws (1);
- Remove the support and turn it. If there are any cuts, replace it with a new one.

Reassemble and then:

- Check correct levelling with the working bench (3);
- Execute a cutting cycle without workpiece at low descent speed so as to recreate the cutting seat (4) in the support (2).

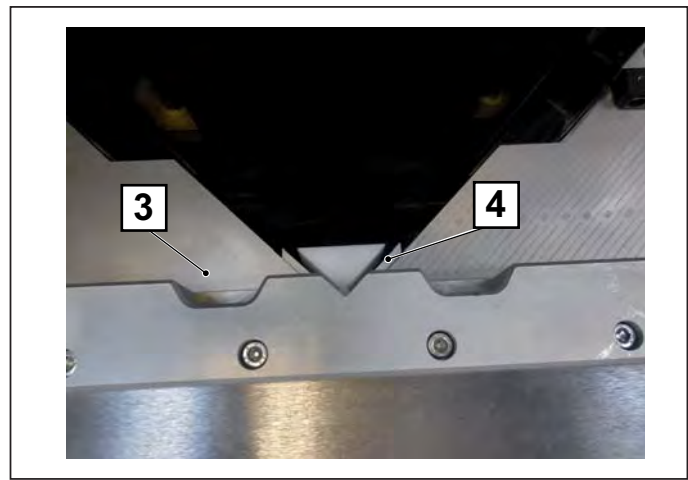
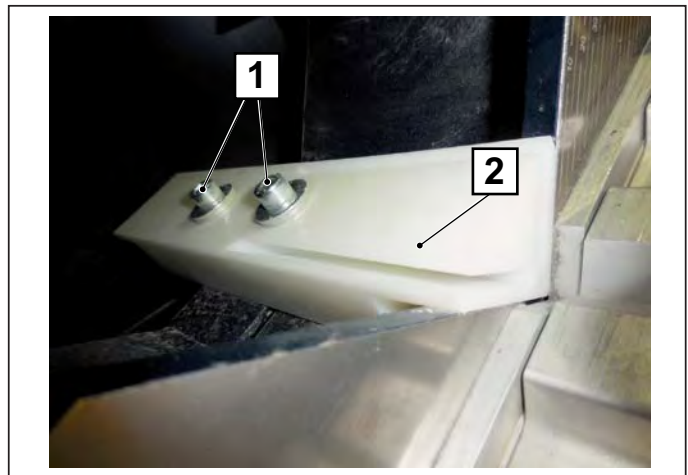

Check the oil level in the pneumatic unit

(Every 6 months)

To carry out this check unscrew the cup (5) and top up with oil if necessary.



Lubricator adjustment

(When necessary)

To adjust the lubricator simply insert a suitable screwdriver (6) into the adjustment screw (7).

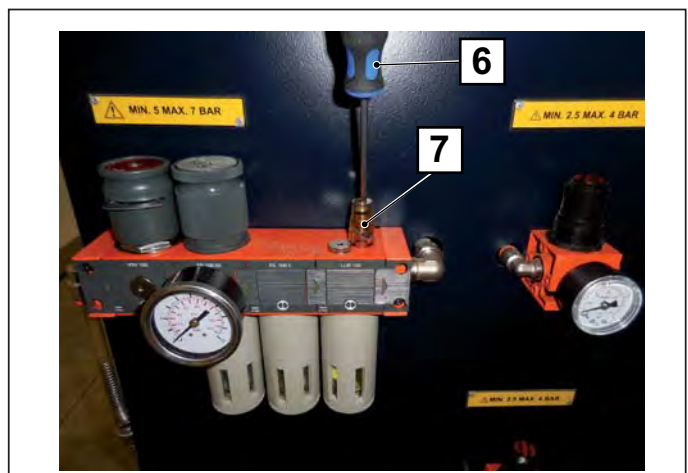

5.6.3 CLEANING

**DANGER – CAUTION**

It is assumed, for the safe use of the assembly, that the reader of this chapter is already familiar with the indications provided in CHAPTER 1.7 “SAFETY INSTRUCTIONS”. Pay particular attention to the residual risks linked to cleaning operations.

**DANGER – CAUTION**

Clean the external surfaces of the machine on a regular basis to prevent dust deposits from building up. It is the user’s responsibility to establish a maintenance plan which includes periodical removal of dust.

**DANGER – CAUTION**

It is forbidden to remove shavings while the blades are running and the cutting unit is not in the stand-by position.

**DANGER – CAUTION**

It is prohibited to manually clean, oil or grease moving machine parts and elements unless this is strictly necessary for some specific technical requirement. If this is the case all suitable measures must be taken to prevent hazards.

Workers must be informed by means of clearly visible warning signs.

Cleaning operations which can be performed by maintenance technicians are indicated below.

Normally, some cleaning operations can be performed by the machine runner; i.e., in the case of normal operations on the outside of the machine that call for the use of simple personal protective equipment..

Cleaning operations of the internal parts of the machine must be performed by the maintenance service.

All cleaning operations must be carried out only after the machine has been cut off from external power supplies and all accumulated energy has been discharged.

**DANGER – CAUTION**

Never use petrol, solvents or other inflammable and/or corrosive fluids to clean the machine or its components. Use exclusively commercial, approved non-flammable and non toxic solvents.

The machine, its on-board components must never be washed with water, especially not in the form of jets of any type or intensity; i.e. it must not be washed using buckets, hoses, or even sponges.

For the identification of the components mentioned and details on their position, refer to the “mechanical components” layout and the layout provided with the machine.

Fixed guards must be removed in order to gain access to some of the parts requiring lubrication.

Fixed guards are identified by the following sign:



Once all cleaning operations have been completed, all the fixed guards must be refitted and secured in place.

FREQUENCY	PERSONNEL	ZONE - METHODS
When necessary	Also the operator	<p>THE WORKING BENCH must be kept clean of work residues (dust, shavings or swarf). The machine is fitted with a swarf conveying system and dust extractor system which can be connected to a suction system (supplied as an OPTIONAL).</p>
At least once every week	Also the operator	<ul style="list-style-type: none"> • THE WORKPLACE AND THE CONTROL STATION must be kept clean and tidy. Remove all dust and dirt. An untidy workplace increases the risk of accidents. • Avoid the use of rubbing alcohol, benzene, solvents or any other type of detergent on non-metal parts which, when necessary can be cleaned using a neutral, non-foaming, water-based detergent ONLY . If necessary, metal parts can be cleaned using a lint-free cloth dampened slightly with rubbing alcohol, taking great care however not to come into contact with any adjacent or nearby plastic materials. Never use abrasive products, coloured substances, metal scourers, wire brushes, scrapers, etc. • Comply with the methods of use and use all the necessary PERSONAL PROTECTIVE EQUIPMENT SPECIFIED BY THE SUPPLIER OF SUCH SUBSTANCES.
At least once every six months	Maintenance technician	<ul style="list-style-type: none"> • Remove all rust marks that may have formed on unpainted surfaces during transport or storage. For this operation use a specific commercial antirust agent. • CONDENSATE IS DISCHARGED by means of the valves installed at the bottom of the tanks inside the machine and the filter cups. • CONDENSATE MUST ALWAYS BE drained before it reaches the level of the filtering elements or the filter separators. • When cleaning, do not use synthetic solvent-based degreasing substances. • Once the filters are clean they can be refitted in the places from which they were removed and the grills must be refitted and fastened in place. Wear a dust mask during cleaning procedures.
Each month	Maintenance technician	<ul style="list-style-type: none"> • Clean the machine using a vacuum cleaner, from the inside of the machine, which can be accessed through the mobile door on the back of the machine. • Check for dust inside the electrical cabinet. If there is any dust, use a vacuum cleaner to remove it. • Check for dust in the pneumatic panel. If there is any dust, use a vacuum cleaner to remove it.

5.6.4 LUBRICATION

During lubrication operations:

1. Avoid bringing oil and/or grease into contact with the skin.
2. During oil and/or grease changes use protective gloves.

Both spent and fresh lubricants are highly polluting: for disposal of lubricants consult your lubricant dealer or contact a specific toxic waste disposal company.

All lubrication operations must be performed:

1. after first cutting off all external energy supplies,
2. strictly observing the safety indications given in the "safety datasheets" provided with each individual lubrication product used.

The lubrication operations which must be performed by maintenance technicians are indicated below.

To obtain high performance and faultless operation, it is important to lubricate moving parts of the machine on a regular basis.

For the disposal of spent oil and grease, observe the relative legislation in force.

Do not disperse spent oil in the environment. Consign it to specifically authorised collection centres.



NOTES

*Fixed guards must be removed in order to gain access to some of the parts requiring lubrication.
Fixed guards are identified by the following sign:*



Once lubrication operations have been completed, all the fixed guards must be refitted and secured in place.

Stem lubrication (by the maintenance technician)

(monthly)

Before proceeding to lubricate the stems (1) carry out adequate cleaning.

Once clean it is possible to proceed with lubrication using a brush to apply a thin coating of lubricant.

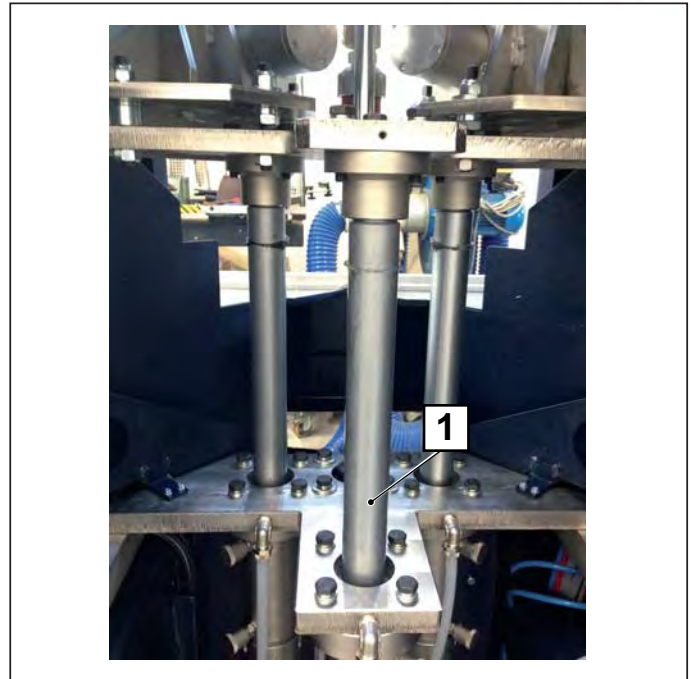
**Grease nipple lubrication (by the maintenance technician)**

(monthly)

To perform lubrication unscrew the plug (2) and apply the necessary grease inside the plug itself.

Tighten the plug.

Repeat this operation for all 6 lubrication points.

Type of grease to use: MOLIKOTE PG21



6. TROUBLESHOOTING AND RELEASE OF MOVING PARTS

If any of the moving parts becomes jammed, in order to release it in conditions of safety the machine operator must first stop the machine and then inform the persons in charge of maintenance, if he has not been authorised to release jammed parts beforehand. The following section describes operations for troubleshooting and releasing moving parts that can be performed by maintenance technicians.

Before performing any work or investigations:

1. Install a sign indicating that maintenance is in progress on the machine
2. Make sure that the upline and downline connected machines do not constitute a source of danger or an impediment to the maintenance work; switch off said machines using the designated procedures.
3. Before restarting the machine, make sure there are no personnel still performing cleaning and /or maintenance operations on it.
4. For mechanical repair work, always seek the assistance of the manufacturer.
5. Always consult the machine manufacture in accordance with the methods specified on the initial pages of this manual.
6. Do not zero/reset the safety devices automatically by means of an external sequence without first checking and identifying the cause of the stoppage.

PROBLEM / FAULT	POSSIBLE CAUSE/S	METHODS AND ANCILLARY NOTES
The control panel appears dead	<ul style="list-style-type: none"> - No power supply - The auxiliary circuits aren't powered 	<ul style="list-style-type: none"> - Check the three-phase power line at source; - Make sure the main power switch is turned to 1 (ON); - Check the fuses in the electrical cabinet;
The control panel is on but the machine won't start.	<ul style="list-style-type: none"> - No compressed air supply to the machine - Main filter regulator release not enabled - low air pressure 	<ul style="list-style-type: none"> -Check the delivery of compressed air from the compressor and the relative pressure; - Activate the release button on the main filter regulator; - adjust the filter regulator pressure to between 5 - 7 bar; - Make sure the line pressure switch is working properly. "
The control panel is on but the machine won't start.	<ul style="list-style-type: none"> - Safety device activated; - Emergency stop button pressed; - No compressed air presence signal; - Motors circuit breaker tripped; - STOP button disabled. 	<ul style="list-style-type: none"> - make sure the front door is closed properly; - make sure the rear door is closed properly; - release and check correct operation of the emergency stop button; - check the pressure switch and compressed air presence; - check to see if thermal overload relays have tripped; - check operation of the stop button;"
The control panel is on, no safety device is active but the machine won't start.	<ul style="list-style-type: none"> - START button disabled. 	<ul style="list-style-type: none"> - check operation of the "start" button.
When the START button is pressed, the pilot light comes on but the blades don't work.	<ul style="list-style-type: none"> - Power is not reaching the motors; 	<ul style="list-style-type: none"> - check/replace the safety fuses.
The blades turn but after a few cycles the machine shuts down.	<ul style="list-style-type: none"> - Insufficient air pressure; - motor/s overload; - safety device intervention." 	<ul style="list-style-type: none"> - check compressed air consumption and pressure; - check the blade descent speed based on the hardness of the material being cut; - make sure the doors are closed properly."
The machine stops after just a few cutting cycles and the motors are very hot	<ul style="list-style-type: none"> - One of the phases powering the motors is missing; - circuit breaker tripped; - brake malfunction 	<ul style="list-style-type: none"> - Make sure all three phases of the power supply line are present; - check the fuses; - check for any breaks in electromechanical component contacts in the electrical cabinet; - check the power supply to the brake; - check brake adjustments,"
The blade stopping time exceeds 10 seconds	<ul style="list-style-type: none"> - the brake is not working properly; - worn brake pad". 	<ul style="list-style-type: none"> - adjust the brake; - replace the brake"

PROBLEM / FAULT	POSSIBLE CAUSE/S	METHODS AND ANCILLARY NOTES
The machine is running but the workpiece isn't clamped when the pedal is pressed	<ul style="list-style-type: none"> - the pedal isn't working; - main air solenoid valve not working; - insufficient air pressure or air leaks; - the clamping control valve isn't working 	<ul style="list-style-type: none"> - replace the pneumatic pedal; - replace the solenoid valve or check the electrical connection; - check the clamping device's pressure regulator; - remove any air leaks; - check/replace the valves.
The machine is running but when the two-hand buttons are pressed the cutting cycle isn't executed	<ul style="list-style-type: none"> - the two buttons aren't being pressed simultaneously; - the buttons don't work; - the safety valve of the two-hand control system is not working; - air leaks from the system. 	<ul style="list-style-type: none"> - the buttons must be pressed at the same time; - check that the buttons work - check operation of the two-hand control system safety valve; - remove any air leaks in the pneumatic system.
The machine is running but when the two-hand control buttons are pressed the cutting unit does not come down.	<ul style="list-style-type: none"> - The main cylinder control valve isn't working properly; - the cylinder blocking valve isn't working - air leaks in the pneumatic system; 	<ul style="list-style-type: none"> - check/replace the main cylinder control valve; - check the cutting unit up/down piloting valve pneumatic circuit; - check operation and opening of the main cylinder lock valve. - remove any air leaks.
The cut workpiece is full of burrs	<ul style="list-style-type: none"> - blades aren't sharp; - central block worn or incorrectly positioned 	<ul style="list-style-type: none"> - sharpen/replace the blades; - adjust/replace the block
The corners of the assembled frame remain open (internal or external vertex)	<ul style="list-style-type: none"> " - The cutting angle of the two blades is not 45°; - the mouldings being cut were not inserted straight and the base surface is not level; - clamping not correctly adjusted 	<ul style="list-style-type: none"> - correct/adjust the blade angle; - replace the material being cut with mouldings of better quality; - check the pressure and position of the vertical clamping stoppers; - try using the horizontal clamp.
The corners on the assembled frame are correct but the two adjoining sections are open in the upper section	<ul style="list-style-type: none"> - verticality of the blades is not correct - the mouldings being cut were not inserted straight and the base surface is not level; - clamping not correctly adjusted 	<ul style="list-style-type: none"> - correct/adjust blade verticality; - replace the workpieces with ones of better quality; - check the pressure and position of the vertical clamping stoppers;
"The finish of the cut is not even; The cut pieces are chipped".	<ul style="list-style-type: none"> - blades aren't sharp; - blades are warped; - vibrations; - workpiece clamping; - cutting speed (blade descent); - quality of the material being cut; - blade not suitable for the type of material being cut; 	<ul style="list-style-type: none"> - sharpen/replace the blades; - check/replace the hubs; - check/replace the belts and check the drive system; - check the regularity of blade unit movements; - check the blade unit balancing system; - check workpiece clamping; - adjust the cutting speed (blade descent) to suit the type of material; - use a blade type which is suitable for the material being cut; - replace the blades; - check the quality of the workpiece material;

7. REINSTALLATION AND REUSE



CAUTION - DANGER

MOVING AND REINSTALLING THE MACHINE IN A DIFFERENT LOCATION ARE HIGHLY DELICATE OPERATIONS WHICH CALL FOR SIGNIFICANT EXPERIENCE. CONSEQUENTLY TO ENSURE THAT THE OPERATIONS ARE CARRIED OUT WITHOUT ANY RISKS FOR PERSONNEL OR THE MACHINE, THESE OPERATIONS MUST BE CARRIED OUT SOLELY AND EXCLUSIVELY BY PERSONNEL APPOINTED DIRECTLY BY THE MACHINE MANUFACTURER OR AUTHORISED BY THE SAME.

8. INSTRUCTIONS FOR EMERGENCIES

The indications on extinguishing media are of fundamental importance as any operations/interventions which are not carried out in compliance with the indications provided below or are not foreseen, may damage the machine, its internal components, the power supply system, the product being handled/produced not to mention injury to operators. Failure to observe the indications will also nullify the warranty.



CAUTION - DANGER

ALL OPERATIONS TO PUT OUT A FIRE MUST BE CARRIED OUT BY PERSONNEL WHO ARE ADEQUATELY INFORMED AND TRAINED CONCERNING THE RISKS AND HAZARDS THAT MAY ARISE DURING EXECUTION OF SAID ACTIVITIES. THEY MUST HAVE READ AND UNDERSTOOD THE SAFETY PRESCRIPTIONS PROVIDED IN THIS INSTRUCTION MANUAL AND BE IN GOOD PSYCHO-PHYSICAL SHAPE.

In the event of a fire affecting parts of the machine, or the processed product, always use a type "C" C₀₂ extinguisher.

A fire extinguisher of this type must be kept next to the machine work station at all times.

9. SCRAPPING AND DISPOSAL



DANGER - WARNING

IF YOU DECIDE NOT YOU NO LONGER WISH TO USE THE MACHINE DESCRIBED IN THIS MANUAL BECAUSE IT HAS BECOME OBSOLETE AND/OR IRREPARABLY DAMAGED OR WORN TO A POINT WHERE ANY FORM OF REPAIR WOULD NOT BE AN ECONOMICALLY VIABLE SOLUTION, IT MUST BE PUT OUT OF SERVICE AND RENDERED INOPERATIVE AND FREE FROM ALL POTENTIAL HAZARDS.

Decommissioning of the machine must be carried out by specialised and suitably equipped personnel.

If the client does not have the right personnel or tools to be able to proceed with demolition of the machine in total safety and in such a way as to safeguard the operators involved, he must seek the assistance of the machine manufacturer's technical staff.

Before starting the scrapping procedures display signs informing persons in the area that work is in progress.

9.1. SCRAPPING



NOTES

To be able to perform the necessary tasks in maximum safety, the areas around the machine, for a whole 360° and over a distance of at least 2000 mm, must be free of walls, other machinery, equipment or other elements, such as support pillars, which might get in the way.



DANGER – CAUTION

Hazards include: hand crushing, falling objects, cuts, abrasions and burns. Operators must wear suitable workwear and/or PPE.

The main sequential stages for dismantling and scrapping include the following (the list is provided as a guideline and is not exhaustive): disassemble all machine components and consign them to an authority or company for differentiated collection in compliance with the relative legislation in force.

All operations to disconnect the machine must be carried out using suitable equipment and tools of an appropriate size (e.g. a flathead or Phillips screwdriver, hex wrenches, Allen keys, etc.), depending on the type of fasteners.

During dismantling procedures do not enter the interior of the machine or climb under or on top of it for any reason: always work while standing alongside the machine.

Before disassembling parts and/or disconnecting and/or loosening any joining elements, take steps to ensure that the connected parts cannot subsequently fall on top of yourself or other exposed persons.

This must be achieved also using ancillary supports or restraints, or approved and certified lifting devices in compliance with statutory legislation in force in your country.

Never carry out dismantling procedures single-handedly. Always make sure there is someone there to provide assistance and/or help in the event of accidents. Said assistant must have the professional training of a maintenance technician or higher.

Pay attention to any decals affixed to the components to be disconnected and next to terminal boxes.

When the machine has been fully dismantled all the identification plates of the machine and all documents referring to the machine must be destroyed.

9.2. DISPOSAL

! DANGER - WARNING
DISPOSE OF THE MACHINE COMPONENTS IN ACCORDANCE WITH OPERATING METHODS WHICH OBSERVE THE MAIN REGULATIONS GOVERNING SAFETY AND ENVIRONMENTAL PROTECTION IN THE COUNTRY OF DISPOSAL.

The machine can be disposed of without having to reduce it to small pieces; simply separate the main units it is made up of and load them onto a lorry for transfer to a scrap merchant.

Clearly, this operation must be performed using adequate lifting and handling equipment including forklifts, hoists, A-frames, overhead travelling cranes, etc., all of which must be approved and certified in compliance with statutory legislation and applicable regulations.

Proceed with disposal operations in accordance with the relative legislation in force by contacting the relative bodies and/or specialized waste disposal companies authorized to handle industrial machinery and/or waste disposal to make sure that all plastics, metal materials and electrical components which must be disposed of separately are duly sorted.

NOTES
 Within the EU all electrical equipment must be disposed of in accordance with EC Directive 2002/96/EC on waste electrical and electronic equipment (WEEE).

The employer must be aware of all the statutory legislation in force in the country of disposal and must operate in compliance with the relative provisions.

It is prohibited to dump the machine in environment. All violations are punishable by law.

IDENTIFICATION DATA

MANUFACTURER

ALFAMACCHINE S.r.l.
 Address
 Via Curie Marie e Pierre, 3 - 47122 FORLI
 Tel. +39 0543 783301 Fax +39 0543 783302
 E-mail: customerservice@alfamacchine.com

Name	DOUBLE MITRE SAW FOR "V" CUTTING
Function	45° CUTTING OF MOULDINGS MADE FROM WOOD, ENGINEERED WOOD AND SIMILAR, HARD PLASTIC AND LIGHTWEIGHT ALLOYS
Model / Type	T300/T350/T400
Serial number	
Year of construction	
Manual Revision	01

DOCUMENT

INSTRUCTION MANUAL

No. of volumes: 1
 Date: 14/07/2016

Revision: 01
 © Copyright 2016 - ALFAMACCHINE S.r.l.

Unless expressly authorized in writing by ALFAMACCHINE S.r.l., this manual nor any part of it, may be copied in any form, modified, transcribed, translated into any language, made available to third parties or in any way used in a manner which could have a negative impact on the interests of ALFAMACCHINE S.r.l..

All violations of the foregoing prescriptions are subject to penalties in compliance with the law and the rules of copyright.

PNEUMATIC DIAGRAM

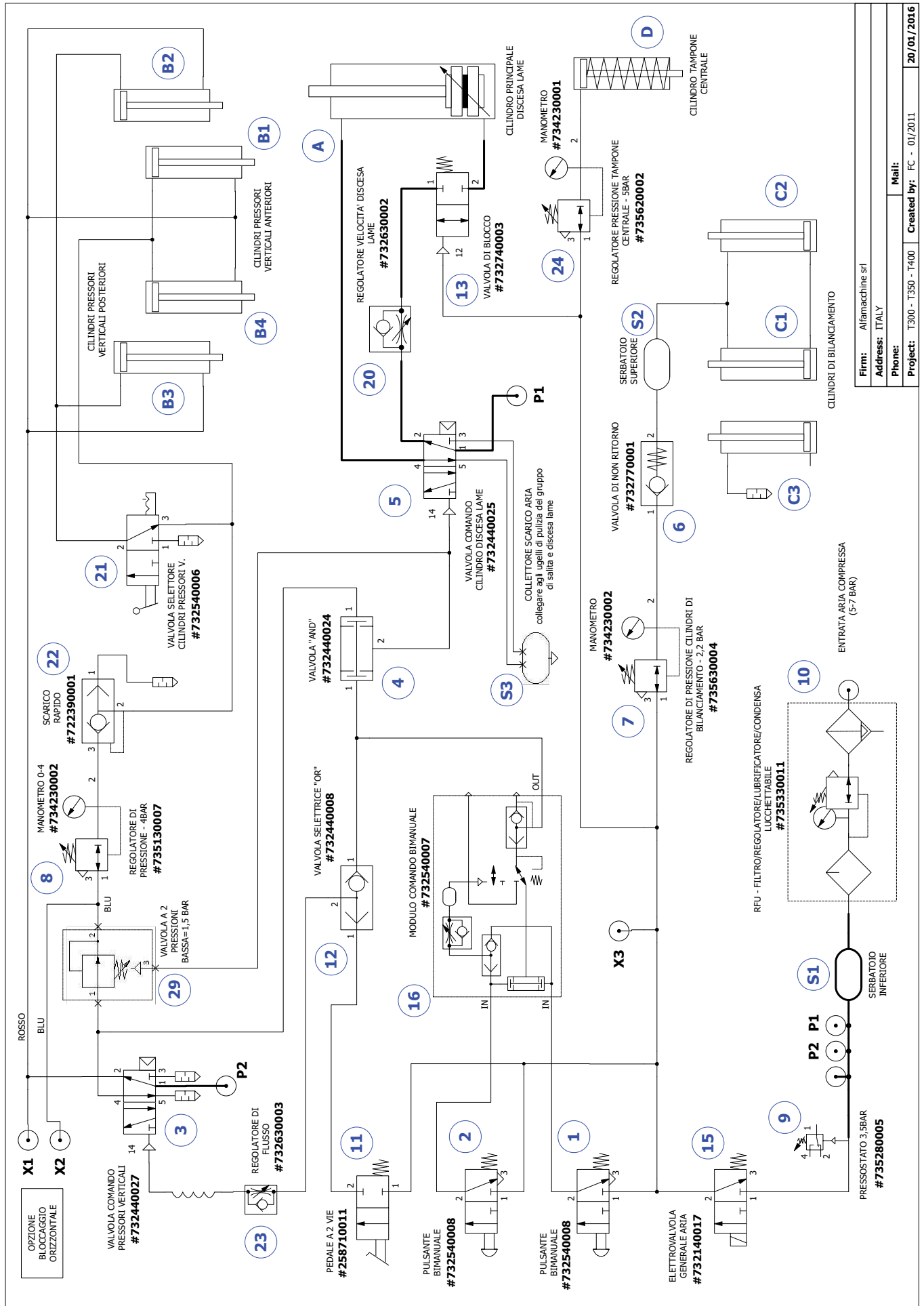

Firm:	Alfamacchine srl
Address:	ITALY
Phone:	
Project:	T300 - T350 - T400
Created by:	FC - 01/2011
	20/01/2016

ELECTRICAL DIAGRAM

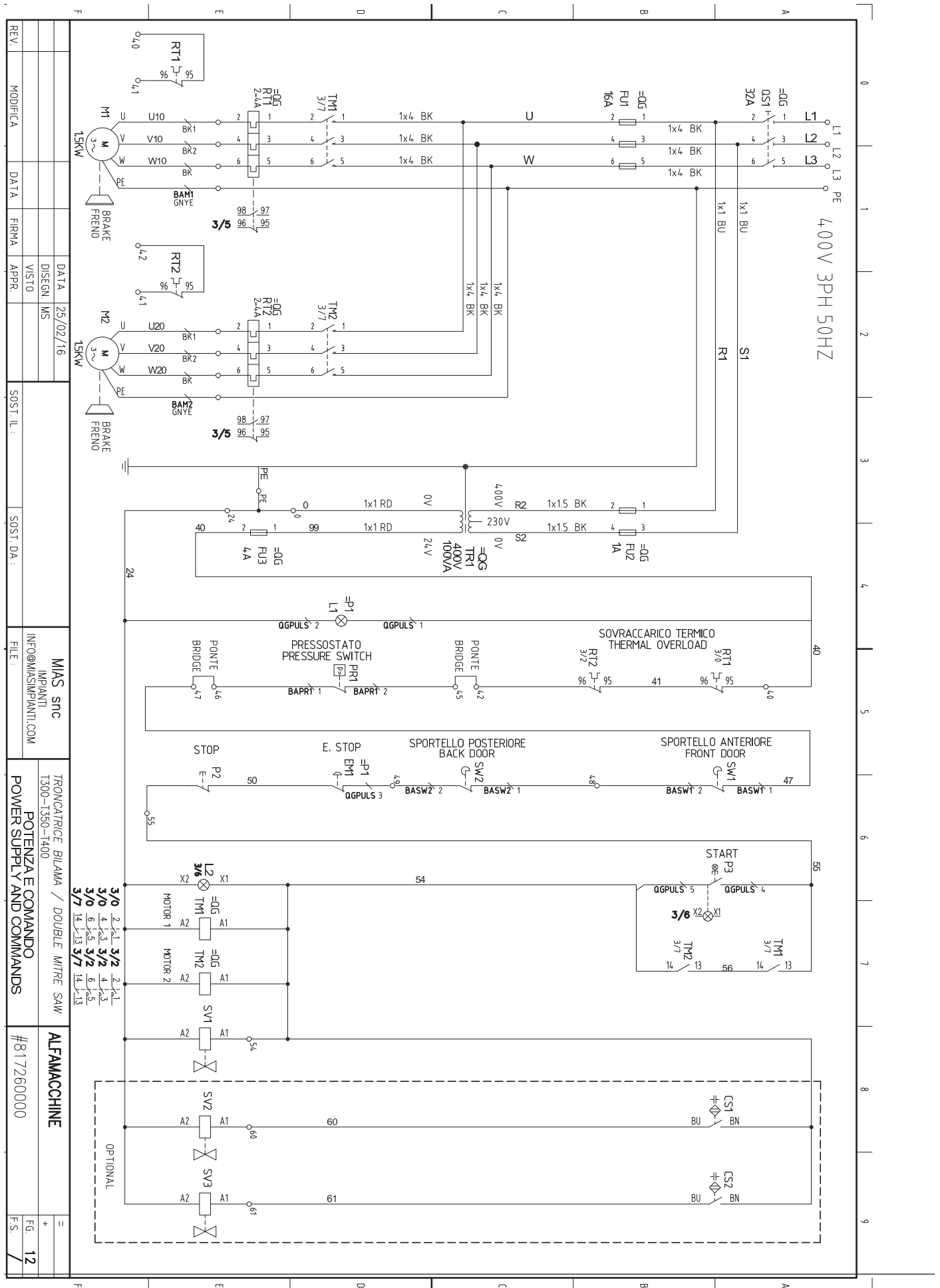

ELECTRICAL SYSTEM ON BOARD THE MITRE SAW MACHINE

**IMPIANTO ELETTRICO BORDOMACCHINA TRONCATRICE
COMPONENTS LAYOUT AND CABLING
MOD: T300 - T350 - T400**

**MORSETTIERA PANNELLO ELETTRICO
MAIN TERMINAL STRIP**

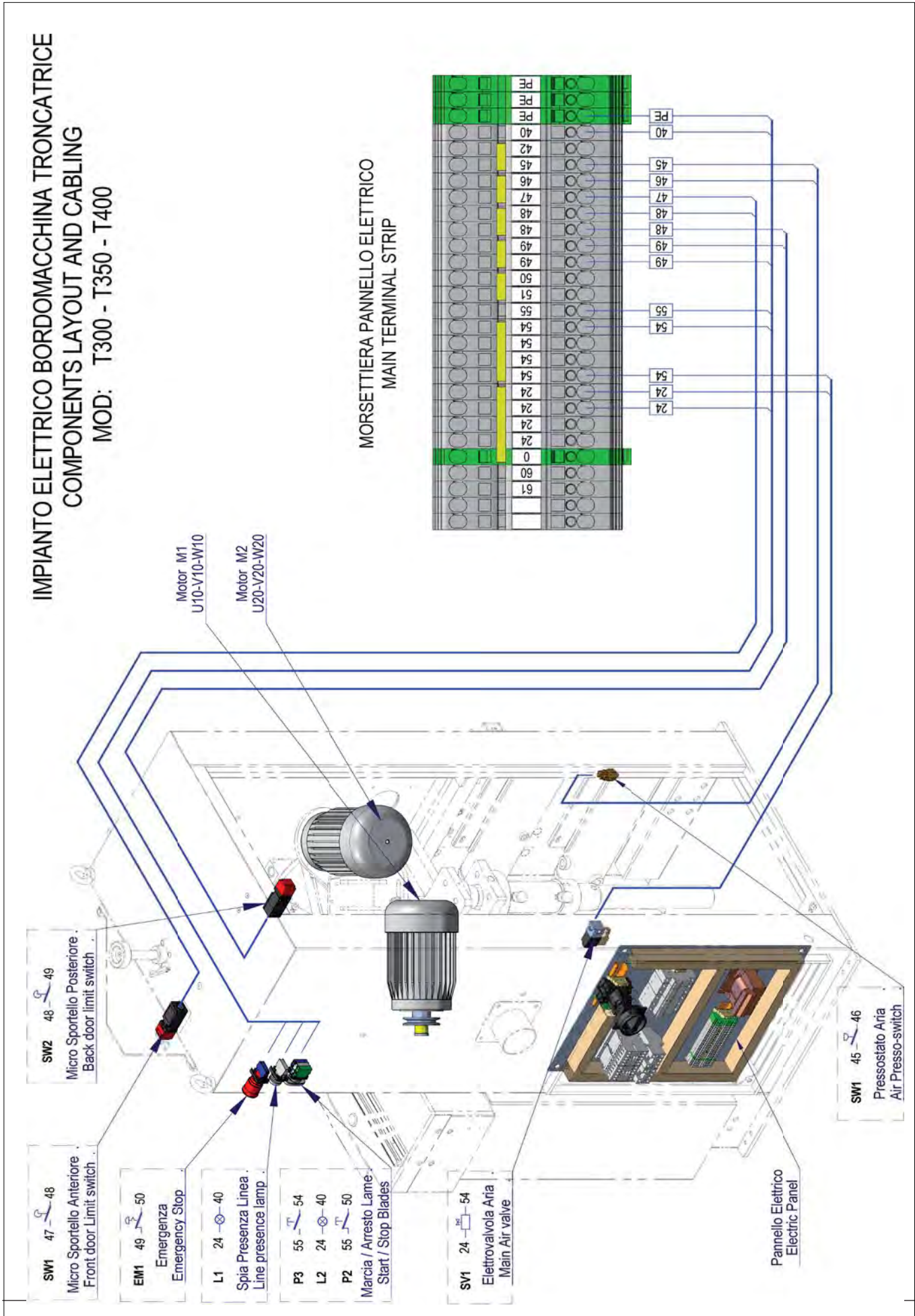



A Fletcher Company

ALFAMACCHINE S.r.l.

Via Curie Marie e Pierre, 3 - 47122 Forlì - FC
Tel. +39-0543/783301 Fax +39-0543/783302
<http://www.alfamacchine.com>